

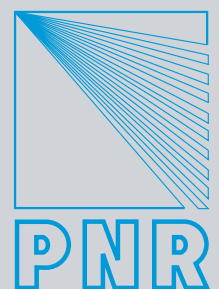

GENERAL PURPOSE SPRAY NOZZLES

CTG UG20 BR



INTRODUCTION

INDEX

Page

SPRAY TECHNOLOGY	1
SPRAY PATTERNS	3
NOZZLE IDENTIFICATION CODES	5
FULL CONE NOZZLES	6
FLAT JET NOZZLES	27
HOLLOW CONE NOZZLES	46
PNR PRODUCT RANGE	55
ADDITIONAL INFORMATION	57

TECHNICAL PUBLICATIONS

Pnr manufactures a complete range of spray nozzles for industrial application, as well as products and systems specially designed for specific industries. Information about our Company and our product range is available through the following publications.

PRODUCT RANGE	CTG TV11
GENERAL PURPOSE SPRAY NOZZLES	CTG UG20
AIR ASSISTED ATOMIZERS	CTG AZ18
COMPLEMENTARY PRODUCTS AND ASSEMBLY FITTINGS	CTG AC20
INDUSTRIAL TANK WASHING SYSTEMS	CTG LS20
EVAPORATIVE COOLING SYSTEMS	CTG LN16
FIRE FIGHTING PRODUCTS	CTG FF10
PAPERMILL PRODUCTS	CTG PM10
STEELWORK NOZZLES	CTG SW20
SPRAYDRY NOZZLES	CTG SP10

As a result of continuous product improvement our documentation is regularly updated and mailed to Customers whose name and address are registered into our Catalogue Mailing List. We shall gladly register your name if you mail to the nearest PNR office or Distributor the form on page 57, duly filled with the required information.

NOTES

Our products and their performances are continuously reconsidered and modified to keep up with the latest state of technology. We regret not to be able to give our Customers previous advice about these modifications: for this reason the data and product specifications given in our Catalogues are always to be understood as being indicative, and do not firmly engage our Company.

In case your application should imperatively require that one or more characteristics of one of our products as given by the Catalogue is strictly adhered to, we ask you to obtain a written confirmation about your requirements before sending your order.

All information contained into this Catalogue, including product data, product codes, diagrams and photographs are the exclusive property of Flowtech. It is forbidden to reproduce any part of this Catalogue without having obtained written permission from Flowtech.

Dimensions in this Catalogue are given in millimetres (mm).

All threads are made according to the ISO 228 standards.

(European norms BS 2779 – DIN 259 – UNI 338).

Explanations about the abbreviations used in the Catalogue are given on page 57.

All mentioned Trademarks are the property of their respective owners.

Please read our Warranty conditions on page 57.

Our factory has qualified
our Quality System
through DNV to the
Norms ISO 9001/2000

**COMPANY
WITH QUALITY SYSTEM
CERTIFIED BY DNV
=ISO 9001/2000=**

LIQUID SPRAY AS A PROCESS

The process of spraying a liquid can be described as composed of two phases, namely:

- 1 Breaking up the liquid into separated drops.
- 2 Directing the liquid drops onto a surface or an object, to achieve the desired result.

The above two phases are normally performed, by the types of nozzles being used in industrial processes, at the same time by means of different techniques which shall be illustrated in the following.

The continuous progress in the manufacturing techniques in recent years has requested the nozzle manufacturer to make available to the industry an always more complete range of spray nozzle types to perform the different processes in a more efficient way.

It is the interest of the engineer using spray nozzles in manufacturing processes to become familiar with the different types of nozzles which are available today and with their individual characteristics, in order to be able to choose the nozzle which performs with the highest possible efficiency on a given application.

Spraying a liquid through a spray nozzle can serve different purposes, among which the most important are the following:

- 1 Cooling, by means of heat transfer between the product itself and the liquid running on its surface.
- 2 Washing, where the water directed onto the product takes away dirt or undesired substances from the product surface.
- 3 Humidifying, with sprays carrying very little liquid quantities to the product surface, into a chamber or into a room.
- 4 Metering the desired liquid quantity in a unit of time into the product being handled.
- 5 Applying a product on a surface, as in the case of spray painting or surface pre-treatment before painting.
- 6 Increasing the liquid surface to speed up heat transfer processes or chemical reactions and many others in numerous applications throughout modern industry.

It is self evident that the best results for every application are only obtained when the right choices in terms of nozzle type, flow value, spray angle, drop dimensions and nozzle material are made.

The purpose of the following pages is to give the reader the basic knowledge which is needed to properly select a spray nozzle for a given application.

SPRAY NOZZLES

A spray nozzle is a device which makes use of the pressure energy of a liquid to increase its speed through an orifice and break it into drops.

Its performances can be identified and described precisely, so that the design engineer can specify exactly the spray nozzle required for a given process.

The relevant characteristics which identify the performances of a nozzle are the following:

- 1 The liquid flow delivered as a function of the nozzle feed pressure.
- 2 The opening angle of the produced spray.
- 3 The nozzle efficiency, as the ratio between the energy of the spray and the energy used by the nozzle.
- 4 The evenness of the flow distribution over the target.
- 5 The droplet size distribution of the spray.

The above characteristics will be discussed in the following pages, in connection with the different nozzle types.

SPRAY TECHNOLOGY

TECHNIQUES FOR SPRAY PRODUCTION

Many different techniques can be used to produce a spray, and most of them are used today for nozzles to be applied in industrial processes. Based on the different techniques, the following nozzle types can be used in industrial applications to generate a liquid spray.

1 PRESSURE NOZZLES

This is the simplest type of nozzles, where an orifice is opened into a chamber where the liquid to be sprayed is fed under pressure. A spray is produced through the orifice with spray pattern, flow rate and spray angle depending upon the orifice edge profile and the design of the inside pressure chamber.

Typical pressure nozzles are the flat jet nozzles series GA, J, GX and GY.

2 TURBULENCE NOZZLES

In these nozzles the liquid moving towards the chamber preceding the orifice is given a rotational speed component, so as to open up in a conical shape as soon as it leaves the orifice edge because of centrifugal force. Based on the nozzle design and the technique used to generate the rotational speed, the drops produced can be confined to the cone outer surface (hollow cone spray) or be evenly distributed to fill the entire volume of the cone (full cone spray).

3 IMPACT NOZZLES

Here the desired spray shape is obtained producing an impact of the liquid jet onto a properly designed surface. The liquid jet is subsequently changed into a fluid lamina and then broken into drops with the desired spray pattern after leaving the nozzle edge.

4 AIR ASSISTED ATOMIZERS

Fine and very fine sprays can be obtained by means of air assisted atomizers, working upon various different principles. More detailed information about air assisted atomizing can be found in our Catalogue "Air assisted atomizers" (ordering code CTG AZ18).

The interested reader can find further information into our Spray Handbook CTG SH02 BR, to be obtained at no cost by any PNR Company or Distributor.

SPRAYING NOZZLE TECHNICAL PARAMETERS

Several technical properties have to be taken into account for properly selecting a nozzle, and will be mentioned on the following page. Among them the following two are of prime interest to the design engineer.

1 NOZZLE EFFICIENCY

A spray nozzle is a device that transforms the pressure energy of a liquid flow into kinetic energy. The nozzle efficiency can be defined as the ratio between the energy available at the nozzle inlet, and the energy which is used to increase the liquid velocity and create the spray, the difference being the energy lost within the process because of friction both inside the liquid and between the liquid and the nozzle inner surface. Depending upon the nozzle type, and for a good quality machining, the nozzle efficiency varies between 55% and 95% for the types commonly used in industrial processes. The above is not valid for air assisted atomizers, which have much higher energy requirements, because of the losses inherent in the energy transfer from compressed air to liquid surface.

2 DROPLET SIZE

For several applications the size of the droplets in the spray is of prime importance to the final result. Considerations about how to define and measure the droplet size of a spray are contained both in our Spray Engineering Handbook (CTG SH02), and in our Catalogue "Air assisted Atomizers" (CTG AZ18).

SPRAY PATTERNS

FULL CONE PATTERN

In a full cone spray the droplets are distributed into a volume which is limited by a cone, having its origin point at the nozzle orifice. Such spray pattern is commonly used in a large variety of industrial processes, since it is the one which allows to distribute in an even way the water flow onto a surface: the full cone spray pattern is therefore useful, as a typical example, to evenly spray cooling liquid on a still surface. Another typical use is to distribute liquid droplets within a certain volume, like for example evenly distributing water droplets in the inside volume of a cooling tower.

Because of the wide number of processes performed by means of full cone nozzles the original shape has evolved into a range of specialised types, where the full cone spray pattern, or a pattern similar to a full cone one, is obtained by different techniques.

STANDARD FULL CONE (TURBULENCE NOZZLE)

These nozzles use a specially shaped vane placed at the nozzle inlet, to give a rotational speed to the fluid flowing through the nozzle.

Because of the rotational speed of the fluid, water exiting the nozzle orifice is subjected to centrifugal force and opens up in the shape of a full cone.

The extent of the angle of the cone is a function of both exit speed (created from the inlet pressure) and the internal design of the nozzle. It can vary in practice from 15° to 120°.

These nozzles can be also produced as square full cone nozzles, where the square shape of the pyramidal spray is obtained by a special design of the outlet orifice.

Two important details have to be noted from the system designer when using these type of nozzles:

- 1 - the spray angle is measured on the side of the square section
- 2 - the square section of the spray rotates within the distance from the nozzle orifice to the target area.

SPIRAL FULL CONE (DEFLECTION NOZZLE)

This is not properly a full cone, but rather a continuous liquid curtain evolving with the shape of a spiral inside a conical volume. The disadvantage of a scarcely even distribution is compensated by an exceptionally good resistance to plugging, which makes this nozzle the best choice in those applications where safety or system reliability are the prime concern, e.g. fire fighting systems.

MULTIPLE FULL CONE (TURBULENCE NOZZLE, AIR ATOMIZER)

This spray pattern is used in two cases, that is:

- A When a wide spray angle is to be reached with nozzles which inherently can only produce a narrow one, or in such cases where small size droplets and rather high capacities are required. Therefore several nozzles are grouped in a cluster with different spray directions: the resulting spray pattern occurs from the additional group of single nozzle sprays and the droplet size of the spray remains the same as one of single nozzle. It must be noted that a smaller nozzle will normally make smaller drops as compared to a larger size nozzle of the same type operating under the same conditions.
- B When it is necessary to obtain a wide angle jet using nozzles which inherently deliver a limited angle spray. In the case of a wide angle air atomizer, for example, the droplet distribution is obviously not homogeneous and the result is rather a number of small angle sprays with different directions, but still the liquid is atomized towards all the parts of the volume to be treated



STANDARD FULL CONE



SPIRAL FULL CONE



MULTIPLE FULL CONE

SPRAY PATTERNS

FLAT JET SPRAY PATTERN



In a flat jet spray the liquid droplets are sprayed in the shape of a flat liquid layer, with different thickness according to the principle used to generate the spray. A flat jet spray nozzle serves the purpose of spraying onto a surface or an object moving in a transverse direction with respect to the one of the jet surface, a typical example being the nozzles in a car washing tunnel. The vast majority of flat spray nozzles used in the industry work according to one of the following principles.

IN LINE FLAT JET (PRESSURE NOZZLE)

This is the general purpose flat jet nozzle, where the liquid enters the nozzle in line with the axis length and is fed to a pressure chamber, from where it is ejected through the nozzle orifice. Flow value and spray angle are determined respectively from the orifice cross section and the orifice edge profile.



IN LINE STRAIGHT JET (PRESSURE NOZZLE)

These nozzles can be considered a special kind of flat jet nozzle, with naught degree spray angle. They are designed to produce a sharp stable stream, with powerful impact on a given point, and serve normally to perform cleaning processes or to cut soft materials.

SPOON FLAT JET (DEFLECTION NOZZLE)

In this type of nozzle the liquid is fed under pressure to a round outlet orifice, and then deflected onto a smooth profiled surface so as to assume a flat jet shape. This sophisticated design is of advantage since it offers a stronger jet impact using the same feed pressure. Higher efficiency comes from the very little energy required to just change the direction of the liquid flow, this being the only energy required to generate the flat jet.

HOLLOW CONE SPRAY PATTERN



A hollow cone spray pattern consists of droplets concentrated onto the outer surface of a conical shape volume, with no droplets contained in the inside of the conical jet shape. These nozzles are normally used for smoke washing or gas cooling applications in several industrial processes.

HOLLOW CONE (TURBULENCE NOZZLE)

These nozzles use a tangential injection of liquid into a whirling chamber to generate centrifugal forces which break up the liquid vein as soon as it leaves the orifice. Precisely designed orifice profiles, making use of the Coanda effect, provides the ability to obtain very large spray angles.



HOLLOW CONE (DEFLECTION NOZZLE)

A hollow cone can also be obtained taking a liquid flow to change direction onto a properly designed surface, in order to break the liquid into droplets and distributing them as a hollow cone spray pattern.

This kind of nozzle is mainly used for applications in dust control and fire fighting systems.

NOZZLE IDENTIFICATION CODES

PNR CODING SYSTEM

As any other industrial product, spray nozzles need to be precisely identified by means of a code in order to avoid mistakes.

PNR coding system has been designed with the following requirements in mind:

- Codes must be easily processed by a computer, in ascending order.
- Codes must describe completely the product without any need for additional description.
- Codes must show to the user the basic specifications of the nozzle in order to ease the search in the catalogue.

We have therefore determined our coding system described as follows:

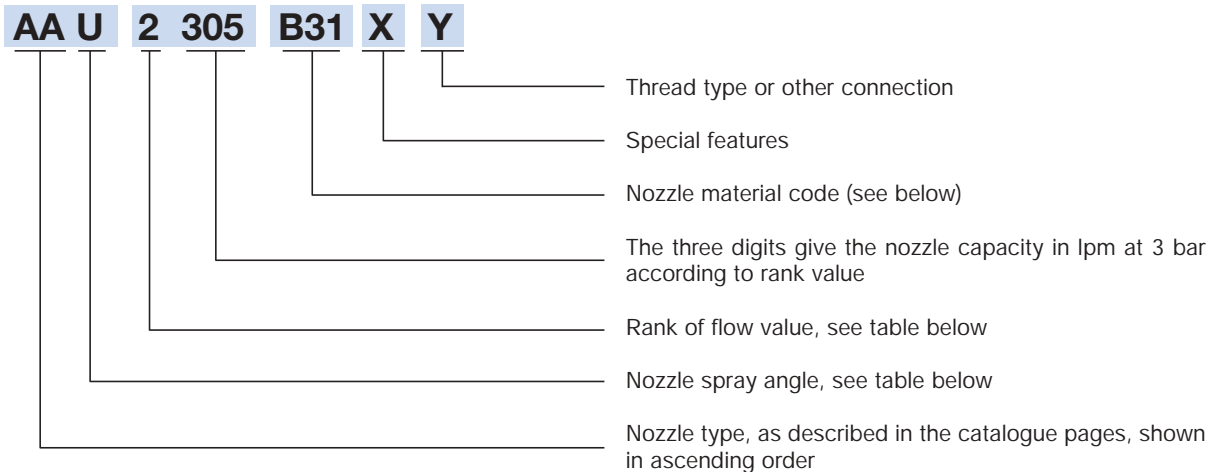

Nozzle tables report on a blue background the nominal flow value, measured at 3,0 bar. Flow values at different pressures have been calculated.

These codes serve as an indication only.

Based on different types of nozzles, their significance can occasionally be different.

Capacity rank

Rank	Flow digits	Actual flow (l/min)
0	0 490	0,49
1	1 490	4,90
2	2 490	49,0
3	3 490	490
4	4 490	4900

Some spray angle codes (degrees)

A = 0	L = 40	T = 80
B = 15	M = 45	U = 90
C = 20	N = 50	J = 110
D = 25	Q = 60	W = 120
F = 30	R = 65	Y = 130
H = 35	S = 75	Z = 180

NOZZLE MATERIAL CODES

A1	Carbon steel
A2	High speed steel
A8	Zinc coated steel
A9	Nickel coated steel
B1	AISI 303 Stainless steel
B2	AISI 304 Stainless steel
B21	AISI 304 L Stainless steel
B3	AISI 316 Stainless steel
B31	AISI 316 L Stainless steel
C2	AISI 416 Stainless steel, hardened
D1	Polyvinylchloride (PVC)
D2	Polypropylene (PP)
D3	Polyamide (PA)
D5	Talcum filled Polypropylene

D6	Glassfibre reinforced PP
D7	High density polyethylene
D8	Polyvinylidene fluoride (PVDF)
E0	EPDM
E1	Polytetrafluorethylene (PTFE)
E2	PTFE (25% glassfibers)
E31	Acetalic resin (POM)
E7	Viton
E8	Synthetic rubber (NBR)
F5	Ceramic
F31	Ruby insert, 303 body
G1	Cast iron
H1	Titanium
L1	Monel 400

L2	Incolloy 825
L8	Hastelloy C276
P6	Acr. But. Styrene (ABS)
P8	EPDM 40 Shore
T1	Brass
T2	Brass, chrome plated
T3	Copper
T5	Bronze
T8	Brass, nickel plated
T81	Brass, electroless nickel plated
V1	Aluminum
V7	Aluminum, electroless n. plated

FULL CONE NOZZLES RANGE OVERVIEW

A wide choice of full cone nozzles are shown on the following pages, covering any possible requirement for standard industrial processes.

The table below list full nozzle type codes, and beside each type are some general indications about nozzle style, special features, spray pattern and specific applications, in order to assist your choice.

Full cone nozzles are normally delivered in brass or AISI 316 Stainless steel, while a wide choice of other materials like PVC, Polypropylene, Teflon, Hastelloy, Titanium can be supplied on request.

Please note that nozzles shown in this Catalogue are listed for general purpose applications, additional nozzle types designed specifically for specific applications are shown in other Catalogues as listed on the back cover page and shown at page 55.



FULL CONE
Round spray

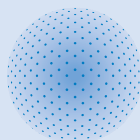

FULL CONE
Cluster spray

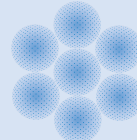

FULL CONE
Square pattern

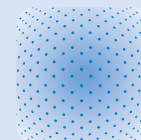

Type	Connection	Design	Feature	Pattern	Recommended	Page
AA	Male thread	In line	Short body	Round	Plastic materials	07
AE	Flange	In line	Large capacity	Round	Coke quench	08
AL	Male/Female	In line	Non clogging	Round	General	09
AT	Male thread	Tangential	Non clogging	Round	Demister wash	10
BA	Female thread	In line	Three pieces	Round	Cleanable	11
BB	Female thread	In line	Three pieces	Square	Cleanable	12
BC	Male thread	In line	Three pieces	Round	Cleanable	11
BD	Male thread	In line	Three pieces	Square	Cleanable	12
BE	Female thread	In line	Cast body	Round	General	13
BF	Female thread	In line	Cast body	Square	General	15
BG	Male thread	In line	Small capacity	Round	General	13
BH	Male thread	In line	Two pieces	Square	Surface cooling	15
BL	Flange	In line	Large capacity	Round	General	14
BR	Female thread	In line	Narrow spray	Round	Cleanable	16
BS	Male thread	In line	Narrow spray	Round	Cleanable	16
BX	Nipple & nut	In line	Manifold mount	Round	Continuous casting	17
CA	Female thread	In line	Cluster jet	Round	Cooling	18
D	Male thread	In line	Two pieces	Round	General	20
E	Male thread	In line	Non clogging	Spiral	Scrubbers	24

FULL CONE NOZZLES

AA

SLOTTED VANE

Type AA full cone nozzles are made out of a body and a slotted vane, for even spray distribution.

This type of construction offers a nozzle length generally shorter than other types, and it is used in applications where strict space requirements are to be met.

Connection thread is parallel, according to BSP standards.

Typical applications in gas cooling, washing processes and fire fighting systems.

Their compact design makes them the best choice where a plastic material like PVC, PP or PTFE is required. The robust construction of the vane prevents it collapsing when subjected to high temperature, also there is a price advantage resulting from less material being required to provide a nozzle of shorter length.

In addition these nozzles can be readily manufactured from almost any machineable material, making them the best choice when urgent delivery is requested.

- Materials B31 AISI 316L Stainless steel
- T1 Brass
- D All plastic materials on request

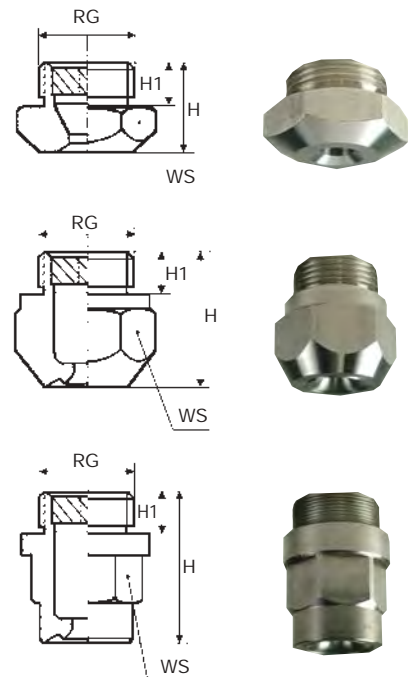

Code	RG inch	D mm	D1 mm	Capacity at different pressure values (lpm) (bar)								H mm	H1 mm	WS mm	
				0.5	0.7	1.0	2.0	3.0	5.0	7.0	10				
90°	AAU 2305 xx	3/4	6.1	3.0	12.5	14.7	17.6	24.9	30.5	39.4	46.6	55.7	22	10	32
	AAU 2385 xx		6.7	3.0	15.7	18.6	22.2	31.4	38.5	49.7	58.8	70.3			
	AAU 2490 xx		7.8	4.0	20.0	23.7	28.3	40.0	49.0	63.3	74.8	89.4			
	AAU 2610 xx	1	9.0	4.0	24.9	29.5	35.2	49.8	61.0	78.7	93.1	111	27	12	40
	AAU 2780 xx		10.5	5.0	31.9	37.7	45.1	63.7	78.0	101	119	142			
	AAU 3123 xx	1+1/4	12.5	6.0	50.2	59.4	71.0	100	123	158	187	224	30	14	50
	AAU 3194 xx	1+1/2	16.0	6.0	79.2	93.8	112	158	194	250	296	354			
	AAU 3310 xx	2	20.0	7.0	127	150	179	253	310	400	473	564	45	18	75
	AAU 3386 xx		23.0	9.0	158	186	223	315	386	498	589	703			
	AAU 3490 xx	2+1/2	25.0	12.0	200	237	283	400	490	632	748	894	52	22	90
AAU 3610 xx		28.5	13.0	249	295	352	498	610	787	931	1112				
AAU 3775 xx	3	32.0	16.0	317	375	448	633	775	1000	1183	1412	60	24	110	
120°	AAW 2490 xx	3/4	7.9	3.0	20.0	23.7	28.3	40.0	49.0	63.3	74.8	89.4	38	11	32
	AAW 2780 xx	1	13.7	6.0	31.9	37.7	45.1	63.7	78.0	101	119	142			
	AAW 3123 xx	1+1/4	12.7	6.0	50.2	59.4	71.0	100	123	158	187	224	62	19	50
	AAW 3194 xx	1+1/2	16.0	6.0	79.2	93.8	112	158	194	250	296	354			
	AAW 3310 xx	2	20.0	10.0	127	150	179	253	310	400	473	564	99	24	60
	AAW 3386 xx		22.7	10.0	158	186	223	315	386	498	589	703			
	AAW 3490 xx	2+1/2	25.5	12.0	200	237	283	400	490	632	748	894	123	27	75
	AAW 3610 xx		30	13.0	249	295	352	498	610	787	931	1112			
	AAW 3775 xx	3	32.0	14.0	317	375	448	633	775	1000	1183	1412	150	30	85

While AA type nozzles are available on request in several materials, the different sizes are normally stocked or produced in brass, PVC and 316 stainless steel according to the Material Table beside. Also, please note that the wrench sizes given in the above table refer to brass nozzles, while stainless steel and plastic bars may have different sizes.

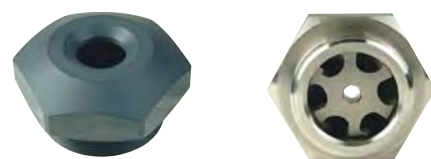

AA nozzles design is ideally suited for plastic materials.

Slotted disc vane

MATERIAL	3/4"	1"	1+1/4"	1+1/2"	2"	2+1/2"	3"
AISI 316					•	•	•
Brass	•						
PVC	•	•	•	•	•	•	•

FULL CONE NOZZLES

AE

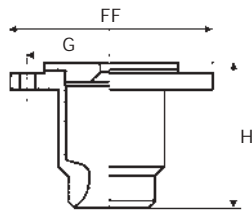

SLOTTED VANE

AE type nozzles are designed to deliver large and very large capacity values, with a carefully designed and machined inside profile, which offers uniform spray distribution and perfect performance even with very low inlet pressure values.

The nozzle is made from castings or welded from steel sheet according to its size, and has an upper flange, normally Nominal Pressure equal to 16 bar, for connection to the feed line.

Typical application for these nozzle is coke quenching and any other application requesting efficient cooling over large surfaces and inside conditioning towers.

Materials A1 Carbon steel
B3 AISI 316 Stainless steel
G1 Cast iron

Code	DN mm	D mm	D1 mm	Capacity at different pressure values								FF mm	G mm	H mm	
				0.25	0.35	0.5	0.7	1.0	2.0	3.0	5.0				
90°	AEU 3940 xx	80	37	12	340	405	442	520	599	788	940	1195	200	160	140
	AEU 4118 xx		39	14	425	505	568	670	740	987	1180	1480			
	AEU 4147 xx	100	43	13	535	630	700	830	940	1230	1470	1825	220	180	156
	AEU 4188 xx	125	53	16	680	810	900	1060	1180	1595	1880	2340	250	210	177
	AEU 4235 xx		56	16	845	1010	1128	1335	1495	1975	2350	2590			
	AEU 4294 xx	150	59	21	1065	1265	1398	1650	1880	2490	2940	3630	285	240	188
	AEU 4370 xx		66	24	1345	1593	1795	2120	2320	3140	3700	4610			
	AEU 4470 xx	200	72	28	1710	2020	2180	2565	2995	3930	4700	5860	340	295	250
	AEU 4588 xx		81	32	2135	2530	2760	3300	3635	4940	5880	7310			
	AEU 4741 xx	250	88	39	2650	3185	3590	4245	4690	6150	7410	9120	395	350	291
AEU 4941 xx		99	37	3410	4050	4520	5350	5980	7880	9410	11650				
120°	AEW 3940 xx	80	36	15	340	405	442	520	599	788	940	1195	200	160	140
	AEW 4118 xx		40.5	14.5	425	505	568	670	740	987	1180	1480			
	AEW 4147 xx	100	43	18.5	535	630	700	830	940	1230	1470	1825	220	180	156
	AEW 4188 xx	125	53	22	680	810	900	1060	1180	1595	1880	2340	250	210	177
	AEW 4235 xx		55	24	845	1010	1128	1335	1495	1975	2350	2590			
	AEW 4294 xx	150	59	28	1065	1265	1398	1650	1880	2490	2940	3630	285	240	188
	AEW 4370 xx		66	32	1345	1593	1795	2120	2320	3140	3700	4610			
	AEW 4470 xx	200	75	35	1710	2020	2180	2565	2995	3930	4700	5860	340	295	250
	AEW 4588 xx		81	40	2135	2530	2760	3300	3635	4940	5880	7310			
	AEW 4741 xx	250	86	37	2650	3185	3590	4245	4690	6150	7410	9120	395	350	291
AEW 4941 xx		96	42	3410	4050	4520	5350	5980	7880	9410	11650				

Common Applications

Coke quenching

Cooling

FULL CONE NOZZLES

AL

S-TYPE VANE

AL style nozzles offer distinct advantages due to their special construction, with an integrated S-shape vane cast in one piece with the nozzle body.

Because of their special design they offer the largest free passage available in a full cone nozzle (actually identical to the nozzle orifice diameter) and can easily handle dirty or recirculated liquids as well as foreign matters.

The best reliability is then assured under the most difficult conditions, which makes these nozzles the right choice in those plants with nozzle clogging problems or where removing and cleaning a clogged nozzle is a difficult job.

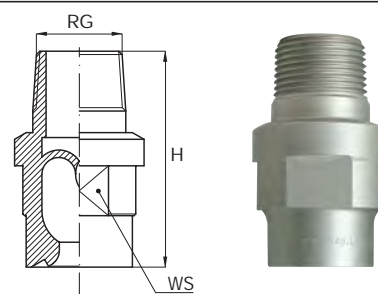

Materials B31 AISI 316 L Stainless steel
Or any castable alloy on request.

ALU 90°	ALW 120°	Code	RG inch	D mm	Capacity at different pressure values							H mm	WS mm	DIA mm	W Kg
					0.25	0.5	1.0	2.0	3.0	4.0	5.0				
•	•	2208 xx	3/8		5.82	8.53	11.9	17.1	20.8	23.9	26.8	38	22		0.10
•	•	2209 xx	1/2		5.82	8.53	11.9	17.1	20.8	23.9	26.8	48	27		0.15
•	•	2373 xx			10.4	15.3	21.3	30.6	37.3	42.9	48.1				
•	•	2671 xx	3/4	8.7	19.4	27.4	38.7	54.8	67.1	77.5	86.6	60	32		0.20
•	•	2792 xx		9.5	22.9	32.3	45.7	64.7	79.2	91.5	102				
•	•	2793 xx	1	9.5	22.9	32.3	45.7	64.7	79.2	91.5	102	75	38		0.35
•	•	2959 xx		10.3	27.5	38.9	55.0	77.7	95.9	110	123				
•	•	3111 xx		11.1	32.0	45.3	64.1	90.6	112	128	143				
•	•	3112 xx	1+1/4	11.1	32.0	45.3	64.1	90.6	112	128	143	86	50		0.60
•	•	3144 xx		12.7	41.3	58.4	82.6	117	144	165	185				
•	•	3160 xx		13.5	45.9	64.9	91.8	130	160	184	205				
•	•	3175 xx		14.3	50.5	71.4	101	143	176	202	226				
•	•	3176 xx	1+1/2	14.3	50.5	71.4	101	143	176	202	226	86	50		0.60
•	•	3198 xx		15.1	57.2	80.8	114	162	198	229	256	112	60		0.90
•	•	3212 xx		15.9	61.2	86.5	122	173	212	245	274				
•	•	3227 xx		16.7	74.2	105	148	210	257	297	332				
•	•	3270 xx		17.5	77.9	110	156	220	270	312	349				
•	•	3328 xx	2	19.0	94.7	134	189	268	328	379	423	160		70	1.6
•	•	3360 xx		20.6	104	147	208	294	360	416	465				
•	•	3445 xx		22.3	128	182	257	363	445	514	574				
•	•	3499 xx		23.8	144	204	288	407	499	576	644				
•	•	3586 xx		25.4	167	237	335	474	586	671	750				
•	•	3714 xx		28.5	206	291	412	583	714	824	922				

AL style nozzles feature a special S-vane design, allowing the narrowest free passage inside the nozzle to be approximately equal to the nozzle orifice diameter.

They offer therefore the widest possible passage among all full cone nozzles working with an internal vane.

**Common Applications**

Fire protection
Gas scrubbers
Cooling
Washing gravel
Dust control

FULL CONE NOZZLES

AT

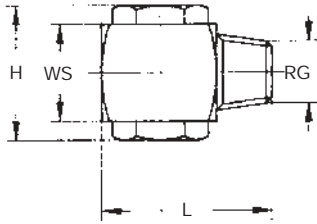

VANELESS - OFF LINE

These nozzles can produce a full cone spray pattern without any vane inside the whirl-chamber, which has free internal passages and is therefore less prone to clogging. The spray axis has an angle of 90° to the axis of the nozzle feed inlet.

The spray consists of coarse drops insensitive to wind drift, well distributed over the spray area and with a stable spray angle over a wide range of inlet pressure values.

Materials B3 AISI 316 Stainless steel
T1 Brass
Plastic materials on request

This type of nozzle is often manufactured in small quantities, special materials and customized specifications, and usually not kept available in stock. Please check with our offices for delivery time about the nozzles you require.

Code	RG inch	D mm	D1 mm	Capacity at different pressure values								H mm	L mm	WS mm		
				1.0	2.0	3.0	4.0	5.0	6.0	7.0	(lpm) (bar)					
60°	ATQ 1390 xx ATQ 1740 xx	1/4	2.4 3.3	2.2 3.2	2.25 4.27	3.18 6.04	3.90 7.40	4.50 8.54	5.03 9.55	5.52 10.5	5.96 11.3	25	34	20		
90°	ATU 1230 xx	1/8	2.1	1.8	1.33	1.88	2.30	2.66	2.97	3.25	3.51	22	24	15		
	ATU 1390 xx ATU 1490 xx	1/4	2.5 3.0	2.1 2.1	2.25	3.18 2.83	3.90 4.00	4.50 4.90	5.03 5.66	5.52 6.33	5.96 6.93	25 7.48	34	20		
	ATU 1621 xx ATU 1740 xx ATU 1780 xx	3/8	3.5 3.3 5.0	3.2 3.2 3.4	3.58 4.27	5.06 6.04	5.06 6.04	6.20 7.40	7.16 8.54	8.00 9.55	8.80 10.5	9.50 11.3	27	34	20	
	ATU 2110 xx ATU 2153 xx ATU 2196 xx		5.1 5.3	4.3 5.2		6.35 8.80	8.98 12.5	11.0 15.3	12.7 17.7	14.2 19.8	15.6 21.6	16.8 23.4				11.9 29.9
	ATU 2245 xx ATU 2315 xx		1/2	8.7 8.7		5.5 6.5	14.1 18.2	20.0 25.7	24.5 31.5	28.3 36.4	31.6 40.7	34.6 44.5				37.4 48.1
	ATU 2530 xx ATU 2770 xx	3/4	12.6 12.6	8.7 11.2	30.6 44.5	43.3 62.9	53.0 77.0	61.2 88.9	68.4 99.4	75.0 109	81.0 109	81.0 118	50 118	58	40	
	ATU 2420 xx ATU 2645 xx	1	9.2 10.3	9.8 10.3	24.2 37.2	34.3 52.7	42.0 64.5	48.5 74.5	54.2 83.3	59.4 91.2	64.2 91.2	64.2 98.5	48 98.5	61	42	
	120°	ATW 1310 xx	1/8	2.5	2.1	1.82	2.48	3.10	3.58	4.02	4.40	4.65	22	24	15	
		ATW 1311 xx ATW 1490 xx	1/4	2.5 4.1	2.1 2.4	1.82 2.83	2.48 4.00	3.10 4.90	3.58 5.66	4.02 6.33	4.40 6.93	4.65 7.48	25	34	20	
		ATW 1780 xx ATW 2110 xx ATW 2153 xx ATW 2196 xx	3/8	5.0 5.4 5.3	3.4 4.4 5.2	4.50 6.35 8.80	6.37 8.98 11.3	7.80 11.0 19.6	9.00 12.7 22.6	10.1 14.2 25.3	11.0 15.6 27.7	11.9 16.8 29.9	27	34	20	
ATW 2245 xx ATW 2315 xx		1/2		8.5 8.5	5.5 6.3	14.1 18.2	20.0 25.7	24.5 31.5	28.3 36.4	31.6 40.7	34.6 44.5	37.4 48.1	38 48.1	48	30	
ATW 2480 xx ATW 2770 xx		3/4		12.6 14.0	7.8 10.7	27.7 44.5	39.2 62.9	48.0 77.0	55.4 88.9	62.0 99.4	67.9 109	73.3 118	56 118	59	40	
ATW 2420 xx ATW 2645 xx ATW 2870 xx ATW 3122 xx		1		9.5 12.8 16.0 18.0	8.0 9.2 11.5 14.0	24.2 37.2 50.2 70.4	34.3 52.7 71.0 99.6	42.0 64.5 87.0 122	48.5 74.5 100 141	54.2 83.3 112 157	59.4 91.2 123 175	64.2 98.5 133 186	48 58 61 66	61 61 68 76	42 40 45 50	

Common Applications

Profile washing in drop eliminators
Rotary filter washing

Accessories

Swivel joints
Line filters

FULL CONE NOZZLES

BA/BC

X-VANE / ROUND SPRAY / THREE PIECES

These full cone nozzles offer a three-piece design based on the clog resistant X-vane design plus the convenience of an easy and fast internal cleaning since they can be easily disassembled for maintenance. The nipple design avoids losing the vane when the nozzle is mounted spraying upwards. Available with female (BA) or male (BC) inlet thread nipple, see dimensions and weights at the bottom the page.

Materials	B1	AISI 303 Stainless steel
	B3	AISI 316 Stainless steel on request
	T1	Brass

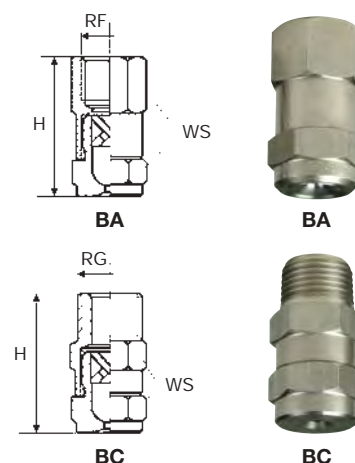

Standard spray

BAQ	BCQ	Code	RF RG	D	D1	Capacity at different pressure values (lpm)							Spray angle (degrees) at pressure (bar)		
						inch	mm	mm	0.7	1.0	2.0	3.0	5.0	7.0	10
•	•	0740	1/8	1.0	0.5	0.36	0.43	0.60	0.74	0.93	1.13	1.35	--	58	53
•	•	1110		1.2	0.5	0.53	0.64	0.90	1.10	1.42	1.68	2.01	51	65	60
•	•	1150		1.4	1.0	0.72	0.87	1.22	1.50	1.94	2.29	2.74	43	59	46
•	•	1220		1.6	1.0	1.06	1.27	1.80	2.20	2.84	3.36	4.02	50	65	60
•	•	1260		1.6	1.3	1.26	1.50	2.12	2.60	3.36	3.97	4.75	43	48	45
•	•	1370		2.0	1.3	1.79	2.14	3.02	3.70	4.78	5.70	6.76	50	65	58
•	•	1480	1/4	2.4	1.7	2.32	2.77	3.92	4.80	6.20	7.30	8.76	45	50	45
•	•	1740		2.9	1.7	3.57	4.27	6.04	7.40	9.60	11.3	13.5	55	65	60
•	•	1930		3.2	1.7	4.46	5.34	7.61	9.30	12.0	14.2	16.9	68	70	67
•	•	1700	3/8	3.0	2.0	3.38	4.04	5.71	7.00	9.03	10.7	12.7	45	50	45
•	•	2111		3.4	2.4	5.36	6.40	9.10	11.1	14.3	17.0	20.3	65	68	60
•	•	2163		4.5	2.4	7.87	9.40	13.3	16.3	21.0	24.9	29.8	85	90	80
•	•	2118	1/2	3.4	3.0	5.70	6.80	9.60	11.8	15.2	18.0	21.5	50	50	45
•	•	2185		4.4	3.0	8.94	10.7	15.1	18.5	23.9	28.3	33.8	65	68	60
•	•	2240		5.0	3.0	11.6	13.9	19.6	24.0	31.0	36.7	43.8	70	75	65
•	•	2300		5.6	3.0	14.5	17.3	24.5	30.0	38.7	45.8	54.8	90	92	85

Wide spray

BAW	BCW	Code	RF/RG	D	D1	0.7	1.0	2.0	3.0	5.0	7.0	10	0.7	1.5	5.0
•	•	1200	1/8	1.5	1.0	0.97	1.15	1.63	2.00	2.58	3.06	3.65	120	115	104
•	•	1310		1.8	1.0	1.50	1.79	2.53	3.10	4.00	4.74	5.66	120	110	104
•	•	1400		2.3	1.0	1.93	2.31	3.27	4.00	5.16	6.11	7.30	120	110	104
•	•	1570		2.5	1.1	2.75	3.29	4.65	5.70	7.36	8.71	10.4	120	110	104
•	•	1720	1/4	3.3	1.7	3.48	4.16	5.88	7.20	9.30	11.0	13.1	120	110	105
•	•	1860		3.4	1.3	4.15	4.97	7.02	8.60	11.1	13.1	15.7	120	110	105
•	•	2100		3.6	1.6	4.83	5.77	8.16	10.0	12.9	15.3	18.3	120	110	105
•	•	2122	3/8	3.9	1.6	5.89	7.04	9.96	12.2	15.8	18.6	22.3	120	110	105
•	•	2144		4.3	2.4	6.96	8.30	11.8	14.4	18.6	22.0	26.3	120	110	105
•	•	2172		4.9	2.4	8.31	9.90	14.0	17.2	22.2	26.3	31.4	120	110	105
•	•	2194		5.3	2.5	9.37	11.2	15.8	19.4	25.0	29.6	35.4	120	110	105
•	•	2220	1/2	5.0	3.0	10.6	12.7	18.0	22.0	28.4	33.6	40.2	120	115	110
•	•	2250		5.3	3.0	12.1	14.4	20.4	25.0	32.3	38.2	45.6	120	115	110
•	•	2290		5.6	3.0	14.0	16.7	23.7	29.0	37.4	44.3	52.9	120	115	110
•	•	2320		6.7	3.5	15.5	18.5	26.1	32.0	41.3	48.9	58.4	120	115	110
•	•	2360		7.6	4.0	17.4	20.8	29.4	36.0	46.5	55.0	65.7	120	115	110

Dimensions and weights

Nozzle Type	RF/RG	H	WS	W
	inch	mm	mm	kg
BA/BB	1/8	30	14	0.03
	1/4	37	17	0.04
	3/8	46	19	0.07
	1/2	57	25	0.20

Nozzle Type	RF/RG	H	WS	W
	inch	mm	mm	kg
BC/BD	1/8	32	14	0.02
	1/4	39	17	0.04
	3/8	47	19	0.07
	1/2	57	25	0.20

FULL CONE NOZZLES

BB/BD



BB

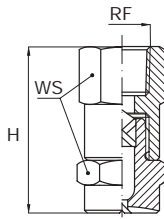

BB



BD

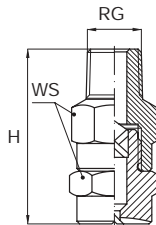

BD

X-VANE / SQUARE SPRAY / THREE PIECES

Same three-piece nozzle can also be manufactured to supply a square section spray pattern, to optimize their performance where the coverage of a surface is required to be as even as possible. Please note that the sides of the square spray section are not in line with the grooves on the nozzle orifice, the offset angle being between 10° and 15° depending upon working pressure and distance. The proper alignment of the nozzles should be obtained at the time when the system is installed or serviced.

Materials	B1	AISI 303 Stainless steel
	B3	AISI 316 Stainless steel on request
	T1	Brass

Square spray

BBQ	BDQ	Code	RF RG	D mm	D1 mm	Capacity (lpm)							Spray angle (degrees)		
						at different pressure values							at pressure		
						0.7	1.0	2.0	3.0	5.0	7.0	10	0.7	1.5	5.0
•	•	1270	1/8	1.8	1.0	1.30	1.56	2.20	2.70	3.49	4.12	4.93	42	55	48
•	•	1360		1.9	1.3	1.74	2.08	2.94	3.60	4.65	5.50	6.57	48	60	60
•	•	1440		2.1	1.3	2.13	2.54	3.59	4.40	5.68	6.72	8.03	60	65	60
•	•	1740	1/4	2.8	1.6	3.57	4.27	6.04	7.40	9.55	11.3	13.5	60	65	60
•	•	1890		3.2	1.6	4.30	5.14	7.27	8.90	11.5	13.6	16.2	65	67	60
•	•	2110		3.8	1.6	5.31	6.35	8.98	11.0	14.2	16.8	20.1	75	80	75
•	•	2133	3/8	3.8	2.4	6.42	7.68	10.9	13.3	17.2	20.3	24.3	70	72	65
•	•	2210	1/2	5.6	3.0	10.1	12.1	17.2	21.0	27.1	32.1	38.3	70	74	65
•	•	2270		6.4	3.2	13.0	15.6	22.0	27.0	34.9	41.2	49.3	75	80	75

Common Applications

Drop production in chemical reactors
Scrubbing and washing with recirculated liquids
Washing and rinsing processes

Accessories

Assembly clamps for feed pipes
Swivel joints
Strainers
One way valves

Dimensions and weights

Nozzle Type	RF/RG inch	H mm	WS mm	W kg
BA/BB	1/8	30	14	0.03
	1/4	37	17	0.04
	3/8	46	19	0.07
	1/2	57	25	0.20

Nozzle Type	RF/RG inch	H mm	WS mm	W kg
BC/BD	1/8	32	14	0.02
	1/4	39	17	0.04
	3/8	47	19	0.07
	1/2	57	25	0.20

FULL CONE NOZZLES

BE/BG

X-VANE/ROUND SPRAY/TWO PIECES

These full cone nozzles have a two-piece design and produce a full cone round spray, with angles ranging between 70° and 120° and capacities between 4.8 and 1040 litres per minute. Higher capacities, up to 11,300 lpm can be obtained with the larger sizes shown in the following table.

The X-vane design assures a satisfactory compromise as far as even coverage of the spray and nozzle resistance to clogging are considered, and is therefore a widely popular choice. The table on this page shows female threaded nozzles up to 3" size, larger capacity nozzles both with female threads and flange connections are shown on the next page. Please note BE nozzles have a female BSP thread, BG have a male BSPT thread. Dimensions for standard and wide spray angle nozzles are shown on the table at the bottom of this page.

Materials B1 AISI 303 Stainless steel
 B31 AISI 316L Stainless steel
 T1 Brass, only sizes 1" and smaller

Standard spray angles

BES	BGQ	Code	RF RG inch	D mm	D1 mm	Capacity at different pressure values							Spray angle (degrees) at pressure		
						0.5	1.0	2.0	3.0	5.0	7.0	10	0.7	3.0	5.0
	•	1480 xx	1/4	2.3	1.6	1.96	2.77	3.92	4.80	6.20	7.33	8.76	55	60	55
	•	1740 xx		2.9	1.6	3.02	4.27	6.04	7.40	9.55	11.3	13.5	65	62	62
	•	1700 xx	3/8	2.6	2.4	2.86	4.04	5.72	7.00	9.04	10.7	12.8	66	60	55
	•	2111 xx		3.6	2.4	4.53	6.41	9.06	11.0	14.3	17.0	20.3	65	67	60
	•	2163 xx		4.5	2.8	6.65	9.41	13.3	16.3	21.0	24.9	29.8	59	62	60
	•	2185 xx	1/2	4.6	3.2	7.55	10.7	15.1	18.5	23.9	28.3	33.8	64	65	60
	•	2300 xx		6.3	3.6	12.2	17.3	24.5	30.0	38.7	45.8	54.8	58	60	58
	•	2220 xx	3/4	4.9	4.4	9.00	12.7	18.0	22.0	28.4	33.6	40.2	54	60	56
	•	2350 xx		6.4	4.4	14.3	20.2	28.6	35.0	45.2	53.5	63.9	56	63	60
	•	2610 xx		9.5	5.2	24.9	35.2	49.8	61.0	78.8	93.2	111	58	65	60
	•	2370 xx	1	6.0	5.6	15.1	21.4	30.2	37.0	47.8	56.5	67.6	58	60	56
	•	2611 xx		8.3	5.6	24.9	35.2	49.8	61.0	78.8	93.2	111	60	61	58
	•	2870 xx		11.9	5.6	35.5	50.2	71.0	87.0	112	133		60	63	60
	•	3104 xx		11.9	6.4	42.5	60.0	84.9	104	134	159		62	65	61
	•	2520 xx		1+1/4	7.4	6.4	21.2	30.0	42.5	52.0	67.1	79.4		72	75
	•	2871 xx	9.6		6.4	35.5	50.2	71.0	87.0	112	133		72	75	68
	•	3105 xx	10.7		6.4	42.9	60.6	85.7	105	136	160		72	75	70
	•	3122 xx	12.3		6.4	49.8	70.4	99.6	122	158	186		72	75	71
	•	3174 xx	15.1		7.9	71.0	100	142	174	225	266		74	75	71
	•	2872 xx	1+1/2	9.5	8.7	35.5	50.2	71.0	87.0	112	133		68	72	65
	•	3139 xx		12.7	8.7	56.7	80.3	113	139	179	212		68	72	70
	•	3175 xx		14.3	8.7	71.4	101	143	175	226	267		72	75	70
	•	3260 xx		18.3	10.3	106	150	212	260	336	397		74	78	73
	•	3148 xx	2	12.7	11.1	60.4	85.4	121	148	191	226		68	70	68
	•	3261 xx		17.3	11.1	106	150	212	260	336	397		70	73	68
	•	3305 xx		19.2	11.1	125	176	249	305	394	466		72	75	70
	•	3350 xx		21.0	11.1	143	202	286	350	452	535		72	75	70
	•	3435 xx		23.8	14.3	178	251	355	435	562	664		71	75	72
	•	3520 xx		28.6	14.3	212	300	425	520	671	794		74	77	72
	•	3215 xx	2+1/2	15.1	14.3	87.8	124	176	215	278	328		70	73	70
	•	3436 xx		22.2	14.3	178	251	355	435	562	664		72	75	70
	•	3521 xx		24.6	14.3	212	300	425	520	671	794		72	75	70
	•	3610 xx		28.6	14.3	249	352	498	610	788	932		73	75	70
	•	3700 xx		28.6	17.5	286	404	572	700	904	1069		73	77	72
	•	3780 xx		31.8	17.5	318	450	637	780	1007	1191		75	78	75
	•	3365 xx	3	19.1	17.5	149	211	298	365	471	558		70	73	68
	•	3701 xx		27.8	17.5	286	404	572	700	904	1069		70	73	70
	•	3781 xx		30.2	17.5	318	450	637	780	1007	1191		72	75	70
	•	3870 xx		32.5	17.5	355	502	710	870	1123	1329		72	75	70
	•	4104 xx		34.9	20.6	425	600	849	1040	1343	1589		75	78	73



BE



BG

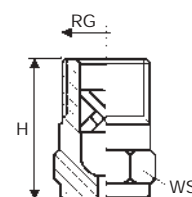

BG

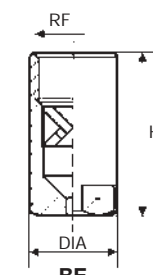

BE

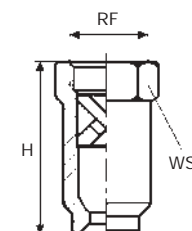

BE

Dimensions

BG	Size	1/8	1/4	3/8	1/2	3/4	1	1+1/4	1+1/2	2	2+1/2	3
	H	mm	19.5	22.0	25.0	33.0	40.0	51.5				
WS	mm	12.0	14.0	17.0	22.0	22.0	27.0					
BE	H	mm				55.5	68.0	90.0	105	140	180	192
	DIA	mm				32.0	38.0					
	WS	mm				27.0	32.0	48.0	52.0	67.0	85.0	100

FULL CONE NOZZLES

BE/BG

X-VANE/ROUND SPRAY/TWO PIECES

Wide spray angles

BEW	BGW	Code	RF RG	D	D1	Capacity at different pressure values							Spray angle (degrees) at pressure			Dimension mm		
						(lpm) (bar)							(bar)			mm		
						0.5	1.0	2.0	3.0	5.0	7.0	10	0.7	3.0	5.0	H	DIA	WS
	•	2100 xx	1/4	3.3	1.6	4.08	5.77	8.16	10.0	12.9	15.3	18.3	115	120	106	23	14	
	•	2122 xx	3/8	3.6	2.4	4.98	7.04	9.96	12.2	15.7	18.6	22.3	115	120	105	30	17	
	•	2144 xx		4.0	2.4	5.88	8.31	11.8	14.4	18.6	22.0	26.3	115	120	105			
	•	2172 xx		5.1	2.4	7.02	9.93	14.0	17.2	22.2	26.3	31.4	115	120	105			
	•	2194 xx		5.2	2.8	7.92	11.2	15.8	19.4	25.0	29.6	35.4	115	120	105			
	•	2220 xx	1/2	5.0	3.0	8.98	12.7	18.0	22.0	28.4	33.6	40.2	115	120	105	39	22	
	•	2250 xx		5.4	3.0	10.2	14.4	20.4	25.0	32.3	38.2	45.6	115	120	105			
	•	2290 xx		6.4	3.0	11.8	16.7	23.7	29.0	37.4	44.3	52.9	115	120	105			
	•	2320 xx		6.9	3.0	13.1	18.5	26.1	32.0	41.3	48.9	58.4	115	120	105			
	•	2360 xx		7.6	3.0	14.7	20.8	29.4	36.0	46.5	55.0	65.7	115	120	110			
•	•	2500 xx	3/4	8.7	4.5	20.4	28.9	40.8	50.0	64.5	76.4	91.3	105	110	105	40	27	
•	•	2920 xx	1	11.5	5.6	37.6	53.1	75.1	92.0	119.	141		105	110	105	54	34	
•	•	3134 xx	1+1/4	14.0	6.0	54.7	77.4	109	134	173	205		110	115	110	88	48	
•	•	3200 xx	1+1/2	16.5	9.0	81.6	115	163	200	258	306		110	115	110	102	52	
•		3395 xx	2	24.0	11.1	161	228	323	395	510	603		110	115	110	138	67	
•		3590 xx	2+1/2	26.0	14.3	241	341	482	590	762	901		110	115	110	162	85	
•		3800 xx	3	32.0	17.5	327	462	653	800	1033	1222		110	115	110	187	100	

BE/BL

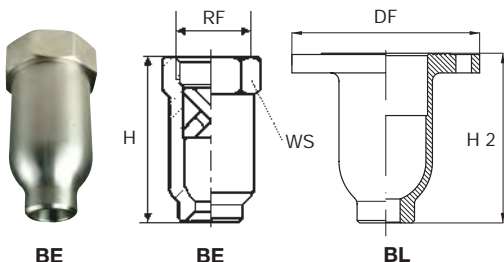

X-VANE/LARGE CAPACITIES

The large capacity nozzles feature a full cone spray pattern with uniform distribution over a round impact area, for applications where a very large capacity is required (values up to 11.300 litres per minute). They are manufactured with large spray angles, while still assuring high water density per square meter. The bodies are machined from a casting, and can be finished either with a female thread connection (BE type) or with an integral ANSI flange (BL type).

Materials B31 AISI 316L Stainless steel
 G1 Cast iron

Large capacity

90°	BEU	BLU	Code	RF DF	D	D1	Capacity at different pressure values							Dimension mm			
							(lpm) (bar)							(bar)			mm
								0.7	1.0	2.0	3.0	5.0	7.0	10	H	H2	WS
90°	•	•	4139 xx	4	43	19	671	803	1135	1390	1794	2123	2538	251	207	130	
	•	•	4157 xx		47	22	758	906	1282	1570	2027	2398	2866				
	•	•	4174 xx		51	25	840	1005	1421	1740	2246	2658	3177				
	•	•	4183 xx		54	25	884	1057	1494	1830	2363	2795	3341				
	•	•	4218 xx	5	48	29	1053	1259	1780	2180	2814	3330	3980	311	269	170	
	•	•	4244 xx		53	29	1179	1409	1992	2440	3150	3727	4455				
	•	•	4279 xx		68	35	1348	1611	2278	2790	3602	4262	5094				
	•	•	4287 xx		73	35	1386	1657	2343	2870	3705	4384	5240				
	•	•	4305 xx	6	61	41	1473	1761	2490	3050	3938	4659	5569	366	321	200	
	•	•	4348 xx		70	41	1681	2009	2841	3480	4493	5316	6354				
	•	•	4392 xx		77	44	1894	2263	3201	3920	5061	5988	7157				
	•	•	4418 xx		82	44	2019	2413	3413	4180	5396	6385	7632				
	•	•	4435 xx	8	70	48	2101	2511	3552	4350	5616	6645	7942	470	423	240	
	•	•	4520 xx		80	47	2512	3002	4246	5200	6713	7943	9494				
	•	•	4610 xx		91	47	2947	3522	4981	6100	7875	9318	11137				
	•	•	4694 xx		102	57	3352	4007	5666	6940	8960	10601	12671				
	•	•	4785 xx		124	57	3792	4532	6409	7850	10134	11991	14332				
	•	•	4695 xx	10	102	57	3357	4013	5675	6950	8972	10616	12689		527		
	•	•	4870 xx		102	64	4202	5023	7104	8700	11232	13289	15884				
	•	•	5104 xx		122	67	5024	6004	8492	10400	13426	15886	18988				
	•	•	5113 xx		135	67	5458	6524	9226	11300	14588	17261	20631				
	•	•	5113 xx		135	67	5458	6524	9226	11300	14588	17261	20631				

120°	BEW	Code	RF DF	D	D1	Capacity (lpm) at pressure (bar)							Dimension mm		
						(lpm) (bar)							(bar)		
						0.7	1.0	2.0	3.0	5.0	7.0	10	H	H2	WS
120°	•	4158 xx	4	47	22	758	906	1282	1570	2027	2398	2538	251	207	130

FULL CONE NOZZLES

BF/BH

X-VANE/SQUARE SPRAY/TWO PIECES

A simpler two piece design is used for BF and BH type nozzles producing a square section spray pattern. Depending upon their size these nozzles are manufactured out of bar stock or casting, drawings, dimensions and weights as shown.

They are the convenient choice where the coverage of a surface is required to be as even as possible.

Please note that the sides of the square spray section are not in line with the grooves on the nozzle orifice, the offset angle is between 10° and 15° depending upon working pressure and distance.

The proper alignment of the nozzles should be obtained at the time when the system is installed or serviced.

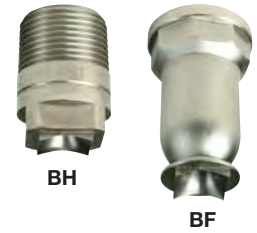

Materials	B1	AISI 303 Stainless steel
	B31	AISI 316L Stainless steel
	T1	Brass

Standard spray angle

BFS	BHQ	Code	RF RG inch	D mm	D1 mm	Capacity at different pressure values (lpm) (bar)							Spray angle (degrees) at pressure (bar)		
						0.7	1.0	2.0	3.0	5.0	7.0	10	0.7	3.0	5.0
	•	1270	1/8	1.7	1.3	1.30	1.56	2.20	2.70	3.49	4.12	4.93	52	60	58
	•	1350		1.9	1.3	1.74	2.08	2.94	3.60	4.65	5.50	6.57	58	60	60
	•	1440		2.2	1.3	2.13	2.54	3.59	4.40	5.68	6.72	8.03	60	65	60
	•	1740	1/4	2.8	1.6	3.57	4.27	6.04	7.40	9.55	11.3	13.5	62	65	60
	•	1890		3.2	1.6	4.30	5.14	7.27	8.90	11.5	13.6	16.2	62	65	60
	•	2107		3.8	1.6	5.17	6.18	8.74	10.7	13.8	16.3	19.5	65	65	60
	•	2133	3/8	4.0	2.4	6.42	7.68	10.9	13.3	17.2	20.3	24.3	60	62	60
	•	2210	1/2	5.5	3.2	10.1	12.1	17.2	21.0	27.1	32.1	38.3	62	64	60
	•	2270		6.4	3.2	13.0	15.6	22.0	27.0	34.8	41.2	49.2	62	65	60
	•	2370	3/4	6.7	4.4	17.8	22.0	31.0	37.0	47.8	56.5	67.5	60	64	62
	•	2780	1	1.9	1.3	37.7	45.2	64.3	78.0	101	120	142	77	78	75
	•	3131	1+1/4	2.4	1.3	63.3	75.6	107	131	169	200	239	77	78	73
	•	3170	1+1/2	2.8	1.6	82.1	98.1	139	170	219	260	310	75	78	70
	•	3215	2	3.2	1.6	104	124	176	215	278	328	392	65	72	68
	•	3265		3.8	1.6	128	153	216	265	342	405	484	73	75	68
	•	3355		1.6	1.3	171	205	290	355	458	542	648	73	75	70
	•	3360	2+1/2	1.9	1.3	174	208	294	360	465	550	657	64	70	63
	•	3435		2.4	1.3	210	251	355	435	562	664	794	75	80	73
	•	3700		2.8	1.6	338	404	571	700	904	1069	1278	73	76	74
	•	4220	5	1.9	1.3	1063	1270	1796	2200	2840	3361	4017	73	75	72
	•	4420		6	2.4	1.3	2029	2425	3429	4200	5422	6416	7668	75	78

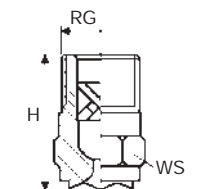
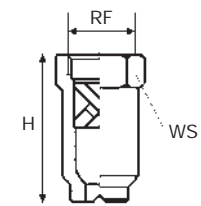
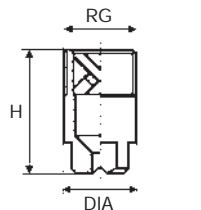
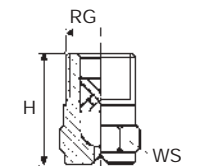

Wide spray angle

BFW	BHW	Code	RF RG	D	D1	0.7	1.0	2.0	3.0	5.0	7.0	10	0.7	3.0	5.0
	•	2100	1/4	3.2	1.6	4.83	5.77	8.16	10.0	12.9	15.3	18.3	106	115	100
	•	2122		3.9	1.6	5.89	7.04	9.96	12.2	15.8	18.6	22.3	105	120	110
	•	2144		4.0	2.4	6.96	8.31	11.8	14.4	18.6	22.0	26.3	105	120	110
	•	2172		4.6	2.4	8.31	9.93	14.0	17.2	22.2	26.3	31.4	105	120	105
	•	2194		5.4	2.4	9.37	11.2	15.8	19.4	25.0	29.6	35.4	105	120	106
	•	2220	1/2	4.8	3.0	10.6	12.7	18.0	22.0	28.4	33.6	40.2	105	110	105
	•	2250		5.1	3.0	12.1	14.4	20.4	25.0	32.3	38.2	45.6	105	110	105
	•	2290		5.7	3.0	14.0	16.7	23.7	29.0	37.4	44.3	53.0	105	110	105
	•	2320		7.0	3.0	15.4	18.5	26.1	32.0	41.3	48.9	58.4	105	110	105
	•	2360		8.0	3.0	17.4	20.8	29.4	36.0	46.5	55.0	65.7	105	110	105
	•	2500	3/4	8.5	4.5	24.2	28.9	40.8	50.0	64.5	76.4	91.3	105	115	103
	•	2930		1	11.6	5.6	44.9	53.7	75.9	93.0	120	142	170	107	110
	•	3134	1+1/4	14.5	6.0	64.7	77.4	109	134	173	205	245	108	110	107
	•	3200	1+1/2	18.2	9.0	96.6	115	163	200	258	305	365	108	115	108
	•	3395		2	24.0	11.1	191	228	322	395	510	603	721	110	112
	•	3590	2+1/2	26.0	14.3	285	341	482	590	761	901	1077	110	115	110
	•	3800		3	31.5	17.5	386	462	653	800	1032	1220	1460	110	120

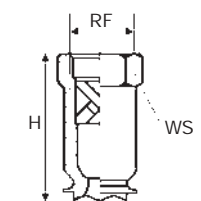
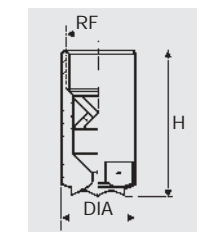

Size inch	1/8	1/4	3/8	1/2	3/4	1	1+1/4	1+1/2	2	2+1/2	3	5	6
H mm	22	23	30	39	55	70	88	102	138	175	187	311	366
WS mm	12	14	17	21	27	32	40	50	60	85	100	170	200
DIA mm					32	38							
W kg	0.01	0.02	0.03	0.04	0.20	0.35	0.55	0.80	1.6	2.0	7.8	18	25

Dimensions and weights

Values are based on the largest/heaviest nozzle for each single size.

FULL CONE NOZZLES

BR/BU



BT



BR



BS

X-VANE/NARROW SPRAY ANGLES

These nozzles produce a solid cone spray with round spray pattern, where coarse water drops are concentrated within a narrow spray angle to maximise their impact force per square surface unit.

Spray angle values of 15° or 30° are available, with a choice of male or female thread connection.

The BR and BS nozzle types are manufactured in three pieces, to allow for easy disassembly and cleaning of the nozzles in case of clogging.

Materials	B1	AISI 303 Stainless steel
	B3	AISI 316 Stainless steel on request
	T1	Brass

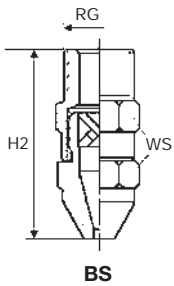

BS

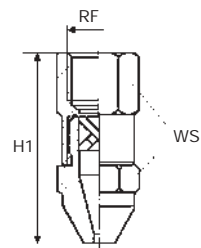

BR

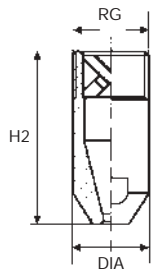

BT

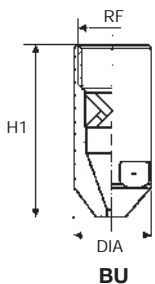

BU

Spray angle 15°

BRB	BSB	BUB	Code	RF RG inch	D mm	Capacity at pressure					Dimensions mm			
						1.0	2.0	3.0	5.0	10	(lpm) (bar)	DIA	H1	H2
•	•		1270 xx	1/8	1.6	1.56	2.20	2.70	3.50	4.90		33	35	12
•	•		1550 xx		2.3	3.18	4.49	5.50	7.10	10.0				
•	•		2117 xx	1/4	3.2	6.75	9.60	11.7	15.1	21.4		44	44	17
•	•		2196 xx	3/8	4.2	11.3	16.0	19.6	25.3	35.8		53	53	22
•	•		2352 xx	1/2	5.6	20.3	28.7	35.2	45.4	64.3		72	72	24
		•	2587 xx	3/4	7.8	33.9	47.9	58.7	75.8	107	32	72		25
		•	3110 xx	1	10.2	63.5	89.8	110	142	201	40	92		35
		•	3168 xx	1+1/4	12.6	97.0	137	168	217	307	48	117		40
		•	3245 xx	1+1/2	15.1	141	200	245	316	447	60	127		52
		•	3450 xx	2	22.0	260	367	450	581	822	80	183		70
		•	3680 xx	2+1/2	26.0	393	555	680	878	1242	90	223		85
		•	3980 xx	3	31.0	566	800	980	1265	1789	105	268		100

Spray angle 30°

BRF	BSF	BTF	Code	RF RG inch	D mm	Capacity at pressure					Dimensions mm			
						1.0	2.0	3.0	5.0	10	(lpm) (bar)	DIA	H1	H2
•	•		0980 xx	1/8	1.0	0.57	0.80	0.98	1.27	1.79		33	35	12
•	•		1160 xx		1.2	0.92	1.31	1.60	2.07	2.92				
•	•		1270 xx		1.6	1.56	2.20	2.70	3.49	4.93				
•	•		1350 xx	1/4	1.8	2.02	2.86	3.50	4.52	6.39		44	44	17
•	•		1550 xx	3/8	2.3	3.18	4.49	5.50	7.10	10.0		53	53	22
•	•		2117 xx	1/2	3.2	6.75	9.55	11.7	15.1	21.4		72	72	24
•	•		2195 xx	3/4	4.2	11.3	15.9	19.5	25.0	36.0		84	87	25
		•	2270 xx	1	5.1	15.6	22.0	27.0	35.0	49.0	34		92	35
		•	2390 xx		6.1	23.0	32.0	39.0	50.0	71.0				
		•	2590 xx	1+1/4	7.4	34.0	48.0	59.0	76.0	108	42		117	40
		•	2780 xx		8.6	45.0	64.0	78.0	101	142				
		•	2980 xx	1+1/2	9.6	57.0	80.0	98.0	127	179	48		127	52
		•	3117 xx		10.5	68.0	96.0	117	151	214				
		•	3137 xx	2	11.1	79.0	112	137	177	250	60		200	55
		•	3156 xx		11.9	90.0	127	156	201	285				
		•	3195 xx		13.5	113	159	195	252	356				
		•	3235 xx	2+1/2	14.7	136	192	235	303	429	70		254	60
		•	3275 xx		15.9	159	224	275	355	502				
		•	3390 xx		19.1	225	318	390	503	712				
		•	3430 xx		19.8	248	351	430	555	785				
		•	3470 xx		20.6	271	384	470	606	857				

Common Applications

Washing and cooling inside pipes
washing of products
Agitating liquids inside tanks and vats.

FULL CONE NOZZLES

BX

NOZZLE TIPS

Full cone tips produce a uniform full cone shaped spray with a round impact area.

Complete nozzles made out of nozzle tip, seal, nipple and retaining nut. This design allows the nozzle to be disassembled and readily cleaned in case of clogging, for fast and easy maintenance.

In addition to metal nipples a range of pipe clamps is available, please see our Accessories Catalogue CTG AC20.

Materials B1 AISI 303 Stainless steel
T1 Brass

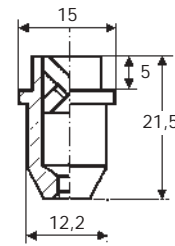

BX 1508 1743

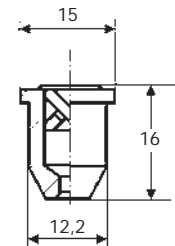

BX 1149 1372

Code	D mm	Capacity at pressure (lpm)					Spray angle at different pressure (bar)			
		1.0	2.0	3.0	5.0	10	1.5	3.0	5.0	
60°										
BXQ 1149 xx	1.3	0.86	1.22	1.49	1.92	2.72	50	50	45	
BXQ 1223 xx	1.7	1.35	1.90	2.33	3.01	4.25	65	65	49	
BXQ 1262 xx	1.7	1.51	2.14	2.62	3.38	4.78	50	50	46	
BXQ 1372 xx	2.1	2.15	3.04	3.72	4.80	6.79	65	65	59	
BXQ 1508 xx	2.4	2.93	4.15	5.08	6.56	9.30	50	50	46	
BXQ 1626 xx	2.9	3.61	5.11	6.26	8.08	11.4	60	60	55	
BXQ 1743 xx	2.9	4.29	6.07	7.43	10.0	14.0	67	67	61	

Under certain conditions, for example nozzle working upside-down at high temperature or subjected to sudden vacuum in pipes, the nozzle vane can escape from the body and impair the nozzle operation.

As an added safety feature our full cone nozzles with X-vane, up to the 3/8" thread size, have the vane safely secured in places.



BJ

THREADED NOZZLES

Most sizes in the BX range can be obtained as a two-piece nozzle, with a 3/8" female thread.

Capacity and spray angle maintain exactly the same values, nozzle identification code is BJQ.

This is convenient where a damaged nipple does not allow for a tight assembly, and avoids the need for disassembling the pipe and replace the defective nipple, while keeping approximately the same distance between the nozzle orifice and the spray target.

As an example, the nozzle with the same specifications of the BXQ 1372 T1 has the code BJQ 1372 T1.

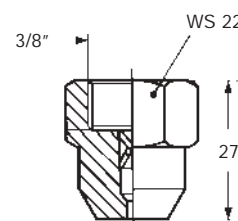

ZAA 1738 xx



VAA 0038 xx

Assembly accessories

BX tips are normally secured with a retaining nut onto a welded nipple.

All details on accessories are shown in our Catalogue CTG AC20.

FULL CONE NOZZLES

CAS

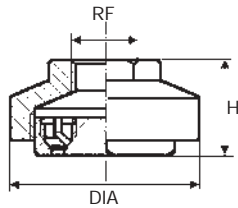

CLUSTER NOZZLE/STANDARD SPRAY

CAS multiple full cone nozzles can produce very fine droplets using only hydraulic pressure.

Their full cone spray pattern results from the interaction of several hollow cone sprays, whose number (NR) is stated in the capacity table below.

Since the droplet size depends among other factors upon the nozzle size, these multi-orifice nozzles produce a finer spray than a standard full cone single-orifice nozzle working at the same pressure and delivering the same quantity of liquid.

Materials B3 AISI 316 Stainless steel on request
 T1 Brass

70°	Code	RF inch	D mm	D1 mm	Capacity at different pressure values						Dimensions mm			
					0.7	1.0	1.5	2.0	3.0	5.0	10	NR	DIA	H
70°	CAS 1153 xx	1/2	0.9	0.5			1.08	1.25	1.53	1.98	2.79	7	50	33.5
	CAS 1274 xx		1.8	0.5			1.94	2.24	2.74	3.54	5.00			
	CAS 1343 xx	3/4	1.1	1.0	1.66	1.98	2.43	2.80	3.43	4.43	6.26	7	72	43
	CAS 1551 xx		1.5	1.4	2.66	3.18	3.90	4.50	5.51	7.11	10.1			
	CAS 1870 xx		2.1	2.0	4.20	5.02	6.15	7.10	8.70	11.2	15.9			
	CAS 2116 xx		2.5	2.0	5.60	6.70	8.20	9.47	11.6	15.0	21.2			
	CAS 2145 xx		3.0	2.0	7.00	8.37	10.2	11.8	14.5	18.7	26.5			
	CAS 2184 xx		3.5	2.0	8.89	10.6	13.0	15.0	18.4	23.8	33.6			
	CAS 2220 xx		4.0	2.0	10.6	12.7	15.6	18.0	22.0	28.4	40.2			
	CAS 2342 xx		3.5	*2.0	16.5	19.8	24.3	28.0	34.3	44.3	62.6			
	CAS 2434 xx		4.0	*2.0	21.0	25.1	30.7	35.4	43.4	56.0	79.2			
	CAS 2551 xx		5.0	*2.0	26.6	31.8	39.0	45.0	55.1	71.1	101			
	CAS 2728 xx		6.0	*2.0	35.2	42.0	51.5	59.4	72.8	94.0	133			
	CAS 2385 xx		1	5.0	2.5	18.5	22.2	27.2	31.4	38.5	49.7			
CAS 2489 xx	6.5	2.5		23.6	28.2	34.5	39.9	48.9	63.1	89.2				
CAS 2685 xx	8.0	2.5		33.1	39.6	48.4	56.0	68.5	88.5	125				
CAS 3130 xx	2	9.0	5.0	62.8	75.1	91.8	106	130	168	237	7	185	103	
CAS 3184 xx		12.0	5.0	88.9	106	130	150	184	237	336				
CAS 3245 xx		15.0	5.0	118	141	173	200	245	316	447				

* Double capacity insert

FULL CONE NOZZLES

CAY

CLUSTER NOZZLE / WIDE ANGLE SPRAY

CAY multiple full cone nozzles can produce very fine droplets using only hydraulic pressure.

Their full cone spray pattern results from the interaction of several hollow cone sprays, whose number (NR) is stated in the capacity table below.

Since the droplet size depends among other factors upon the nozzle size, these multi-orifice nozzles produce a finer spray than a standard full cone single-orifice nozzle working at the same pressure and delivering the same quantity of liquid. The design of CAY nozzle bodies produces a wide angle spray while maintaining the fine droplet dimensions.

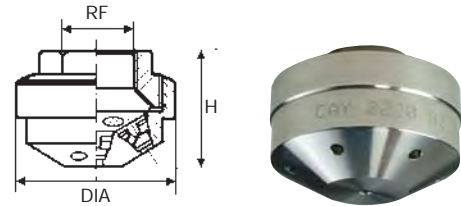

Materials	B1	AISI 303 Stainless steel
	B3	AISI 316 Stainless steel on request
	T1	Brass

130°	Code	RF inch	D mm	D1 mm	Capacity at different pressure values							Dimensions mm		
					0.7	1.0	1.5	2.0	3.0	5.0	10	(lpm) (bar)	NR	DIA
130°	CAY 1153 xx	1/2	1.0	0.5			1.08	1.25	1.53	1.98	2.79	7	40	33.5
	CAY 1274 xx		1.8	0.5			1.94	2.24	2.74	3.54	5.00			
	CAY 1343 xx	3/4	1.0	1.0	1.66	1.98	2.43	2.80	3.43	4.43	6.26	7	63	46
	CAY 1551 xx		1.4	1.4	2.66	3.18	3.90	4.50	5.51	7.11	10.1			
	CAY 1870 xx		2.0	2.0	4.20	5.02	6.15	7.10	8.70	11.2	15.9			
	CAY 2116 xx		2.5	2.0	5.60	6.70	8.20	9.47	11.6	15.0	21.2			
	CAY 2145 xx		3.0	2.0	7.00	8.37	10.2	11.8	14.5	18.7	26.5			
	CAY 2184 xx		3.5	2.0	8.89	10.6	13.0	15.0	18.4	23.8	33.6			
	CAY 2220 xx		4.0	2.0	10.6	12.7	15.6	18.0	22.0	28.4	40.2			
	CAY 2342 xx		3.5	*1.7	16.6	19.8	24.3	28.0	34.2	44.3	62.6			
	CAY 2434 xx		4.0	*1.7	21.0	25.1	30.7	35.4	43.4	56.0	79.2			
	CAY 2551 xx		5.0	*1.7	26.6	31.8	39.0	45.0	55.1	71.1	101			
	CAY 2728 xx	6.0	*1.7	35.2	42.0	51.5	59.4	72.8	94.0	133				
	CAY 2385 xx	1	5.0	3.2	18.6	22.2	27.2	31.4	38.5	49.7	70.3	7	120	81
	CAY 2489 xx		6.0	3.6	23.7	28.3	34.6	40.0	49.0	63.3	89.5			
	CAY 2685 xx		8.0	3.6	33.1	39.5	48.4	55.9	68.5	88.4	125			
	CAY 2979 xx		6.0	*2.5	47.3	56.5	69.2	79.9	97.9	126	179			
	CAY 3137 xx		8.0	*2.5	66.2	79.1	96.9	112	137	177	250			
	CAY 3130 xx	2	9.0	3.2	62.8	75.1	91.9	106	130	168	237	7	155	104.5
	CAY 3184 xx		12.0	3.2	88.9	106	130	150	184	238	336			
CAY 3245 xx	15.0		3.6	118	141	173	200	245	316	447				
CAY 3260 xx	9.0		*3.0	126	150	184	212	260	336	475				
CAY 3367 xx	12.0		*3.0	177	212	260	300	367	474	670				
CAY 3490 xx	15.0		*3.0	237	283	346	400	490	633	895				

* Double capacity insert

FULL CONE NOZZLES

D

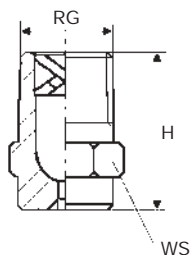

TWO-PIECE NOZZLES

D type nozzles offer a simple and efficient design for a full cone nozzle, that is a wide passage X- style vane assembled into a male threaded body. For sizes up to 3/8" the vane is locked in place, which allows the nozzle to be fitted under any possible orientation without the risk of the vane falling out.

D type nozzles are offered with capacities ranging from 1.18 to 1470 lpm, a full choice of spray angles, and connections from 1/8" to 4". Normally stocked in the materials listed below, they are often manufactured on request in several super-alloys.

Materials	B1	AISI 303 Stainless steel
	B31	AISI 316L Stainless steel
	T1	Brass

How to make up the nozzle code

The coding for D type nozzles uses the second digit to indicate the connection thread size.

Therefore, according to the desired thread size and material, the code for a D type nozzle is to be given as in the following example.

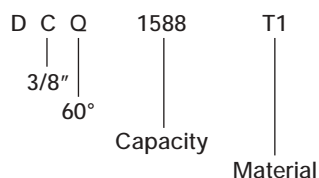

The table below gives coding and dimensions for different thread sizes, for nozzles shown both on this page and the next page.

Thread size coding table

RG inch	Code	H mm	WS mm
1/8	DA	19.5	12.0
1/4	DB	22.0	14.0
3/8	DC	25.0	17.0
1/2	DD	33.0	22.0

Spray angle 45°

DAM	DBM	DCM	DDM	Code	D mm	D1 mm	Capacity at different pressure values (lpm) (bar)						
							0.7	1.0	2.0	3.0	5.0	7.0	10
•				1118 xx	1.1	1.0	0.57	0.68	0.96	1.18	1.52	1.80	2.15
•				1147 xx	1.2	1.1	0.71	0.85	1.20	1.47	1.90	2.25	2.68
•				1188 xx	1.3	1.2	0.91	1.09	1.54	1.88	2.43	2.87	3.43
•				1212 xx	1.4	1.2	1.02	1.22	1.73	2.12	2.74	3.24	3.87
•				1235 xx	1.5	1.3	1.14	1.36	1.92	2.35	3.03	3.59	4.29
•				1294 xx	1.7	1.5	1.42	1.70	2.40	2.94	3.80	4.49	5.37
	•	•		1370 xx	2.0	1.8	1.79	2.14	3.02	3.70	4.78	5.65	6.76
	•	•		1470 xx	2.1	2.0	2.27	2.71	3.84	4.70	6.07	7.18	8.58
	•	•		1588 xx	2.3	2.0	2.84	3.39	4.80	5.88	7.59	8.98	10.7
	•	•		1659 xx	2.5	2.2	3.18	3.80	5.38	6.59	8.51	10.1	12.0
	•	•		1740 xx	2.7	2.3	3.57	4.27	6.04	7.40	9.55	11.3	13.5
			•	1835 xx	2.8	2.6	4.03	4.82	6.82	8.35	10.8	12.8	15.2
			•	1940 xx	3.0	3.0	4.54	5.43	7.68	9.40	12.1	14.4	17.2
			•	2105 xx	3.2	3.2	5.07	6.06	8.57	10.5	13.5	16.0	19.2
			•	2117 xx	3.4	3.3	5.65	6.75	9.55	11.7	15.1	17.9	21.4
			•	2147 xx	3.8	3.7	7.10	8.49	12.0	14.7	19.0	22.5	26.8
			•	2188 xx	4.3	4.3	9.08	10.9	15.4	18.8	24.3	28.7	34.3
			•	2235 xx	5.0	4.5	11.4	13.6	19.2	23.5	30.3	35.9	42.9

Spray angle 60°

DAQ	DBQ	DCQ	DDQ	Code	D	D1	0.7	1.0	2.0	3.0	5.0	7.0	10
•				1118 xx	1.2	0.8	0.57	0.68	0.96	1.18	1.52	1.80	2.15
•				1147 xx	1.3	1.0	0.71	0.85	1.20	1.47	1.90	2.25	2.68
•				1188 xx	1.4	1.1	0.91	1.09	1.54	1.88	2.43	2.87	3.43
•				1212 xx	1.5	1.2	1.02	1.22	1.73	2.12	2.74	3.24	3.87
•				1235 xx	1.6	1.2	1.14	1.36	1.92	2.35	3.03	3.59	4.29
•	•			1294 xx	1.8	1.3	1.42	1.70	2.40	2.94	3.80	4.49	5.37
•	•			1370 xx	2.0	1.4	1.79	2.14	3.02	3.70	4.78	5.65	6.76
	•	•		1470 xx	2.4	1.9	2.27	2.71	3.84	4.70	6.07	7.18	8.58
	•	•		1588 xx	2.6	2.0	2.84	3.39	4.80	5.88	7.59	8.98	10.7
	•	•		1659 xx	2.7	2.0	3.18	3.80	5.38	6.59	8.51	10.1	12.0
	•	•		1740 xx	2.9	2.0	3.57	4.27	6.04	7.40	9.55	11.3	13.5
	•	•		1835 xx	3.2	2.8	4.03	4.82	6.82	8.35	10.8	12.8	15.2
	•	•		1940 xx	3.2	2.8	4.54	5.43	7.68	9.40	12.1	14.4	17.2
	•	•		2100 xx	3.4	3.0	5.07	6.06	8.57	10.5	13.5	16.0	19.2
	•	•		2117 xx	3.6	3.0	5.65	6.75	9.55	11.7	15.1	17.9	21.4
			•	2147 xx	4.0	3.3	7.10	8.49	12.0	14.7	19.0	22.5	26.8
			•	2188 xx	4.5	3.7	9.08	10.9	15.4	18.8	24.3	28.7	34.3
			•	2235 xx	5.2	4.5	11.4	13.6	19.2	23.5	30.3	35.9	42.9
			•	2294 xx	5.8	4.7	14.2	17.0	24.0	29.4	38.0	44.9	53.7

FULL CONE NOZZLES

D

TWO-PIECE NOZZLES

Spray angle 90°

DAU	DBU	DCU	DDU	Code	D mm	D1 mm	Capacity at different pressure values							(lpm) (bar)
							0.7	1.0	2.0	3.0	5.0	7.0	10	
•				1118 xx	1.2	0.8	0.57	0.68	0.96	1.18	1.52	1.80	2.15	
•				1147 xx	1.3	1.0	0.71	0.85	1.20	1.47	1.90	2.25	2.68	
•				1188 xx	1.4	1.2	0.91	1.09	1.54	1.88	2.43	2.87	3.43	
•				1212 xx	1.5	1.2	1.02	1.22	1.73	2.12	2.74	3.24	3.87	
•				1235 xx	1.6	1.3	1.14	1.36	1.92	2.35	3.03	3.59	4.29	
•	•			1294 xx	1.8	1.3	1.42	1.70	2.40	2.94	3.80	4.49	5.37	
•	•			1370 xx	2.0	1.4	1.79	2.14	3.02	3.70	4.78	5.65	6.76	
	•	•		1470 xx	2.3	1.8	2.27	2.71	3.84	4.70	6.07	7.18	8.58	
	•	•		1588 xx	2.6	1.8	2.84	3.39	4.80	5.88	7.59	8.98	10.7	
	•	•		1659 xx	2.7	2.0	3.18	3.80	5.38	6.59	8.51	10.1	12.0	
	•	•		1740 xx	2.9	2.0	3.57	4.27	6.04	7.40	9.55	11.3	13.5	
	•	•		1835 xx	3.3	2.0	4.03	4.82	6.82	8.35	10.8	12.8	15.2	
	•	•		1940 xx	3.3	2.4	4.54	5.43	7.68	9.40	12.1	14.4	17.2	
	•	•		2105 xx	3.5	2.6	5.07	6.06	8.57	10.5	13.5	16.0	19.2	
		•		2117 xx	3.7	2.7	5.65	6.75	9.55	11.7	15.1	17.9	21.4	
		•		2147 xx	4.0	3.2	7.10	8.49	12.0	14.7	19.0	22.5	26.8	
		•		2164 xx	4.1	3.2	7.92	9.47	13.4	16.4	21.2	25.1	29.9	
			•	2188 xx	4.7	3.2	9.08	10.9	15.4	18.8	24.3	28.7	34.3	
			•	2235 xx	5.2	3.8	11.4	13.6	19.2	23.5	30.3	35.9	42.9	
			•	2294 xx	5.8	3.8	14.2	17.0	24.0	29.4	38.0	44.9	53.7	
			•	2370 xx	6.4	3.8	17.9	21.4	30.2	37.0	47.8	56.5	67.6	

Spray angle 120°

DAW	DBW	DCW	DDW	Code	D	D1	0.7	1.0	2.0	3.0	5.0	7.0	10
•				1118 xx	1.2	0.8	0.57	0.68	0.96	1.18	1.52	1.80	2.15
•				1147 xx	1.3	0.9	0.71	0.85	1.20	1.47	1.90	2.25	2.68
•				1188 xx	1.5	1.0	0.91	1.09	1.54	1.88	2.43	2.87	3.43
•				1212 xx	1.6	1.1	1.02	1.22	1.73	2.12	2.74	3.24	3.87
•				1235 xx	1.6	1.2	1.14	1.36	1.92	2.35	3.03	3.59	4.29
•				1294 xx	1.9	1.3	1.42	1.70	2.40	2.94	3.80	4.49	5.37
•				1370 xx	2.1	1.4	1.79	2.14	3.02	3.70	4.78	5.65	6.76
	•	•		1470 xx	2.4	1.6	2.27	2.71	3.84	4.70	6.07	7.18	8.58
	•	•		1588 xx	2.7	1.8	2.84	3.39	4.80	5.88	7.59	8.98	10.7
	•	•		1659 xx	3.0	1.8	3.18	3.80	5.38	6.59	8.51	10.1	12.0
	•	•		1740 xx	3.1	1.9	3.57	4.27	6.04	7.40	9.55	11.3	13.5
	•	•		1835 xx	3.3	1.9	4.03	4.82	6.82	8.35	10.8	12.8	15.2
	•	•		1940 xx	3.5	1.9	4.54	5.43	7.68	9.40	12.1	14.4	17.2
	•	•		2105 xx	3.7	2.3	5.07	6.06	8.57	10.5	13.5	16.0	19.2
		•		2117 xx	3.8	2.4	5.65	6.75	9.55	11.7	15.1	17.9	21.4
		•		2147 xx	4.2	2.7	7.10	8.49	12.0	14.7	19.0	22.5	26.8
		•		2164 xx	4.4	2.7	7.92	9.47	13.4	16.4	21.2	25.1	29.9
			•	2188 xx	4.6	3.1	9.08	10.9	15.4	18.8	24.3	28.7	34.3
			•	2235 xx	5.3	3.3	11.4	13.6	19.2	23.5	30.3	35.9	42.9
			•	2294 xx	5.9	4.1	14.2	17.0	24.0	29.4	38.0	44.9	53.7
			•	2370 xx	6.6	4.7	17.9	21.4	30.2	37.0	47.8	56.5	67.6

FULL CONE NOZZLES

D

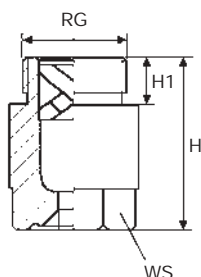

TWO-PIECE NOZZLES/LARGE CAPACITY

The larger nozzles in the D series are widely used in the industry, for a wide variety of applications. They maintain the simple design of the smaller nozzles, with the inherent resistance to clogging due to design of the X-vane, and are often manufactured out of high quality alloys and special plastic materials.

Materials B1 AISI 303 Stainless steel
 B31 AISI 316L Stainless steel
 T1 Brass
 On request special materials are quoted

60°	Code	RG inch	D mm	D1 mm	Capacity at different pressure values						Dimensions mm			
					0.7	1.0	2.0	3.0	5.0	7.0	10	H	H1	WS
60°	DEQ 2235 xx	3/4	4.8	3.5	11.4	13.6	19.2	23.5	30.3	35.9	42.9	43	16	27
	DEQ 2295 xx		5.5	4.5	14.2	17.0	24.1	29.5	38.1	45.1	53.9			
	DEQ 2370 xx		6.0	4.5	17.9	21.4	30.2	37.0	47.8	56.5	67.6			
	DEQ 2470 xx		7.0	4.5	22.7	27.1	38.4	47.0	60.7	71.8	85.8			
	DFQ 2470 xx	1	7.0	5.6	22.7	27.1	38.4	47.0	60.7	71.8	85.8	58	18	36
	DFQ 2590 xx		7.8	5.6	28.5	34.1	48.2	59.0	76.2	90.1	108			
	DFQ 2740 xx		9.5	5.6	35.7	42.7	60.4	74.0	95.5	113	135			
	DGQ 2740 xx	1 1/4	9.5	5.6	35.7	42.7	60.4	74.0	95.5	113	135	74	19	41
	DGQ 3118 xx		12.5	6.0	57.0	68.1	96.3	118	152	180	215			
	DHQ 3147 xx	1 1/2	13.0	9.0	71.0	84.9	120	147	190	225	268	85	19	50
	DKQ 3188 xx	2	15.0	9.0	90.8	109	154	188	243	287	343	106	24	60
	DKQ 3235 xx		16.0	11.0	114	136	192	235	303	359	429			
	DKQ 3294 xx		17.0	11.1	142	170	240	294	380	449	537			
	DLQ 3370 xx	2 1/2	17.5	11.1	179	214	302	370	478	565	676	128	27	75
	DLQ 3470 xx		23.0	11.1	227	271	384	470	607	718	858			
	DMQ 3588 xx	3	28.0	14.3	284	339	480	588	759	898	1074	153	30	85
	DNQ 3740 xx	3 1/2	29.0	17.5	357	427	604	740	955	1130	1351	190	32	105
	DNQ 3940 xx		36.0	17.5	454	543	768	940	1214	1436	1716			
DPQ 4117 xx	4	39.0	19.0	568	678	959	1175	1517	1795	2145	205	36	110	

90°	Code	RG inch	D mm	D1 mm	Capacity at different pressure values						Dimensions mm			
					0.7	1.0	2.0	3.0	5.0	7.0	10	H	H1	WS
90°	DEU 2295 xx	3/4	5.8	3.0	14.2	17.0	24.1	29.5	38.1	45.1	53.9	43	16	27
	DEU 2370 xx		6.4	4.5	17.9	21.4	30.2	37.0	47.8	56.5	67.6			
	DEU 2470 xx		8.0	4.5	22.7	27.1	38.4	47.0	60.7	71.8	85.8			
	DFU 2590 xx	1	8.6	4.5	28.5	34.1	48.2	59.0	76.2	90.1	108	58	18	36
	DFU 2740 xx		9.3	5.0	35.7	42.7	60.4	74.0	95.5	113	135			
	DFU 2830 xx		9.9	6.0	40.3	48.2	68.2	83.5	108	128	152			
	DGU 3118 xx	1 1/4	13.0	6.0	57.0	68.1	96.3	118	152	180	215	74	19	41
	DGU 3147 xx		16.0	6.0	71.0	84.9	120	147	190	225	268			
	DHU 3188 xx	1 1/2	14.5	9.0	90.8	109	154	188	243	287	343	85	19	50
	DKU 3235 xx	2	16.6	11.0	114	136	192	235	303	359	429	106	24	60
	DKU 3294 xx		18.0	11.0	142	170	240	294	380	449	537			
	DKU 3370 xx		25.0	11.0	179	214	302	370	478	565	676			
	DLU 3470 xx	2 1/2	27.0	11.1	227	271	384	470	607	718	858	128	27	75
	DLU 3588 xx		30.0	14.3	284	339	480	588	759	898	1074			
	DMU 3740 xx	3	30.0	17.5	357	427	604	740	955	1130	1351	153	30	85
	DMU 3870 xx		32.5	17.5	420	502	710	870	1123	1329	1588			
	DNU 3940 xx	3 1/2	35.5	17.5	454	543	768	940	1214	1436	1716	190	32	105
	DNU 4117 xx		39.0	19.0	568	678	959	1175	1517	1795	2145			
DPU 4147 xx	4	42.8	25.4	710	849	1200	1470	1898	2245	2684	205	36	110	

FULL CONE NOZZLES

D

TWO-PIECE NOZZLES/LARGE CAPACITY

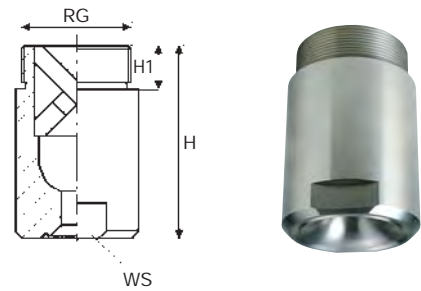

	Code	RG inch	D mm	D1 mm	Capacity at different pressure values							Dimensions mm		
					0.7	1.0	2.0	3.0	5.0	7.0	10	H	H1	WS
120°	DEW 2295 xx	3/4	5.1	3.0	14.2	17.0	24.1	29.5	38.1	45.1	53.9	43	16	27
	DEW 2370 xx		6.5	3.5	17.9	21.4	30.2	37.0	47.8	56.5	67.6			
	DEW 2470 xx		8.5	4.5	22.7	27.1	38.4	47.0	60.7	71.8	85.8			
	DFW 2590 xx	1	11.5	4.5	28.5	34.1	48.2	59.0	76.2	90.1	108	58	18	36
	DFW 2740 xx		12.0	4.5	35.7	42.7	60.4	74.0	95.5	113	135			
	DFW 2830 xx		13.0	5.6	40.3	48.2	68.2	83.5	108	128	152			
	DGW 3118 xx	1 1/4	13.5	6.0	57.0	68.1	96.3	118	152	180	215	74	19	41
	DGW 3147 xx		17.0	6.0	71.0	84.9	120	147	190	225	268			
	DHW 3188 xx	1 1/2	20.0	9.0	90.8	109	154	188	243	287	343	85	19	50
	DKW 3235 xx	2	18.0	11.0	114	136	192	235	303	359	429	106	24	60
	DKW 3294 xx		19.0	11.0	142	170	240	294	380	449	537			
	DKW 3370 xx		21.3	11.0	179	214	302	370	478	565	676			
	DLW 3470 xx	2 1/2	23.5	11.1	227	271	384	470	607	718	858	128	27	75
	DLW 3588 xx		26.5	14.3	284	339	480	588	759	898	1074			
	DMW 3740 xx	3	29.5	17.5	357	427	604	740	955	1130	1351	153	30	85
	DMW 3870 xx		32.0	17.5	420	502	710	870	1123	1329	1588			
DNW 3940 xx	3 1/2	33.5	17.5	454	543	768	940	1214	1436	1716	190	32	105	
DNW 4117 xx		37.0	19.0	568	678	959	1175	1517	1795	2145				
DPW 4147 xx	4	42.0	25.4	710	849	1200	1470	1898	2245	2684	205	36	110	

FULL CONE NOZZLES

E

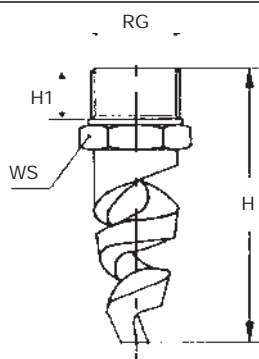

SPIRAL NOZZLES

Spiral nozzles work on the impact principle, by deflection of a water stream onto a spiral profiled surface which provides the desired spray angle.

The spray angle value is maintained even at low pressure and when spraying high viscosity liquids.

While the droplet spray distribution is not comparable to the one provided by a standard full cone nozzle, the fact that a whirling vane is not required makes them virtually clog-free in most cases.

Since spiral nozzles work on the impact principle and have no inherent turbulence losses, they produce faster and smaller droplets as compared to a standard full cone nozzle.

Capacity values on a grey background should be obtained with metal nozzles only, plastic materials being too weak to assure structural nozzle resistance.

See next page for materials, applications and assembly fittings.

Materials B31 AISI 316L Stainless steel
 T1 Brass

The two above materials are usually available in stock, while several other materials as listed on page 25 can be obtained on request.

Code	RG inch	D mm	D1 mm	Capacity at different pressure values								Dimensions mm		
				0.7	1.0	2.0	3.0	5.0	7.0	10	H	H1	WS	
60°	1/4	2.4	2.4	2.66	3.18	4.49	5.50	7.10	8.40	10.0	45	12	14	
		4.0	3.2	7.54	9.01	12.7	15.6	20.1	23.8	28.5				
	3/8	4.8	3.2	11.4	13.6	19.2	23.5	30.3	35.9	42.9	48	14	19	
		6.4	3.2	20.0	24.0	33.9	41.5	53.6	63.4	75.8				
		7.9	3.2	31.2	37.3	52.7	64.6	83.4	99.0	118				
	1/2	9.5	4.7	45.6	54.5	77.1	94.4	122	144	172	64	18	22	
		11.1	4.7	61.8	73.9	105	128	165	196	234				
	3/4	12.7	4.7	79.7	95.3	135	165	213	252	301	70	19	27	
	1	15.9	6.3	126	150	212	260	336	397	475	92	26	34	
	1 1/2	22.2	7.9	245	293	414	507	655	774	926	111	27	50	
90°	1/4	2.4	2.4	2.66	3.18	4.49	5.50	7.10	8.40	10.0	45	12	14	
		3.2	3.2	4.83	5.77	8.16	10.0	12.9	15.3	18.3				
		4.0	3.2	7.54	9.01	12.7	15.6	20.1	23.8	28.5				
	3/8	4.8	3.2	11.4	13.6	19.2	23.5	30.3	35.9	42.9	48	14	19	
		5.6	3.9	15.3	18.3	25.9	31.7	40.9	48.4	57.9				
		6.4	4.8	20.0	24.0	33.9	41.5	53.6	63.4	75.8				
		7.9	5.5	31.2	37.3	52.7	64.6	83.4	99.0	118				
	1/2	9.5	3.3	45.6	54.5	77.1	94.4	122	144	172	64	18	22	
		11.1	3.7	61.8	73.9	105	128	165	196	234				
	3/4	12.7	4.7	79.7	95.3	135	165	213	252	301	70	19	27	
	1	19.0	6.3	126	150	212	260	336	397	475	92	26	34	
		23.0	6.3	180	215	304	372	480	568	679				
	2	34.9	11.1	527	629	890	1090	1407	1665	1990	149	31	65	
	3	44.5	14.3	985	1178	1666	2040	2633	3116	3724	219	42	89	
		50.8		1290	1541	2180	2670	3447	4078	4874				

Operation with pressure values and capacities shown on the grey background recommended for cast or machined metal nozzles only.



The picture shows the inside of a spiral nozzle with a completely free passage, without any internal vane.

FULL CONE NOZZLES

E

SPIRAL NOZZLES

Code	RG inch	D mm	D1 mm	Capacity at different pressure values								Dimensions mm		
				(lpm) (bar)	0.7	1.0	2.0	3.0	5.0	7.0	10	H	H1	WS
120°	EBW 1550 xx EBW 2100 xx EBW 2156 xx	1/4	2.4	2.4	2.66	3.18	4.49	5.50	7.10	8.40	10.0	45	12	14
			3.2	3.2	4.83	5.77	8.16	10.0	12.9	15.3	18.3			
			4.0	3.2	7.54	9.01	12.7	15.6	20.1	23.8	28.5			
	ECW 2156 xx ECW 2230 xx ECW 2317 xx ECW 2410 xx ECW 2640 xx	3/8	4.0	3.2	7.54	9.01	12.7	15.6	20.1	23.8	28.5	48	14	19
			4.8	3.2	11.4	13.6	19.2	23.5	30.3	35.9	42.9			
			5.6	4.0	15.3	18.3	25.9	31.7	40.9	48.4	57.9			
			6.4	4.0	20.0	24.0	33.9	41.5	53.6	63.4	75.8			
			7.9	4.0	31.2	37.3	52.7	64.6	83.4	98.7	118			
	EDW 2940 xx EDW 3104 xx EDW 3128 xx	1/2	9.5	4.8	45.6	54.5	77.1	94.4	122	144	172	64	18	22
			9.7	4.8	50.2	60.0	84.9	104	134	159	190			
			11.1	4.8	61.8	73.9	105	128	165	196	234			
	EEW 3165 xx	3/4	12.7	4.8	79.7	95.3	135	165	213	252	301	70	19	27
			15.9	6.3	126	150	212	260	336	397	475			
	EFW 3260 xx EFW 3372 xx	1	15.9	6.3	126	150	212	260	336	397	475	92	26	34
			19.0		180	215	304	372	480	568	679			
	EHW 3507 xx EHW 3663 xx EHW 3747 xx	1 1/2	22.2	7.9	245	293	414	507	655	774	926	111	27	50
			25.4		320	383	541	663	856	1013	1210			
			28.6		361	431	610	747	964	1141	1364			
EKW 4109 xx EKW 4139 xx	2	34.9	11.1	527	629	890	1090	1407	1665	1990	149	31	65	
		38.1		671	803	1136	1391	1796	2125	2540				
EMW 4204 xx EMW 4265 xx	3	44.5	14.3	985	1178	1666	2040	2634	3116	3725	203	35	90	
		51.0		1280	1530	2164	2650	3421	4048	4838				
EPW 4412 xx	4	63.5	15.9	1990	2379	3364	4120	5318	6293	7522	230	40	127	
150°	ECX 2230 xx ECX 2317 xx ECX 2410 xx ECX 2640 xx	3/8	4.8	3.2	11.4	13.6	19.2	23.5	30.3	35.9	42.9	48	14	19
			5.6	4.0	15.3	18.3	25.9	31.7	40.9	48.4	57.9			
			6.4		20.0	24.0	33.9	41.5	53.6	63.4	75.8			
			7.9		31.2	37.3	52.7	64.6	83.4	98.7	118			
	EDX 2940 xx EDX 3128 xx	1/2	9.5	4.8	45.6	54.5	77.1	94.4	122	144	172	64	18	22
			11.1	4.8	61.8	73.9	105	128	165	196	234			
	EEX 3165 xx	3/4	12.7	4.8	79.7	95.3	135	165	213	252	301	70	19	27
			15.9	6.3	126	150	212	260	336	397	475			
	EFX 3260 xx EFX 3372 xx	1	15.9	6.3	126	150	212	260	336	397	475	92	26	34
			19.0		180	215	304	372	480	568	679			
	EHX 3507 xx EHX 3663 xx EHX 3747 xx	1 1/2	22.2	7.9	245	293	414	507	655	774	926	111	27	50
			25.4		320	383	541	663	856	1013	1210			
28.6				361	431	610	747	964	1141	1364				
EKX 4109 xx EKX 4139 xx	2	34.9	11.1	527	629	890	1090	1407	1665	1990	149	31	65	
		38.1		671	803	1136	1391	1796	2125	2540				
180°	EBZ 2156 xx ECZ 2230 xx	3/8	4.0	2.5	7.54	9.01	12.7	15.6	20.1	23.8	28.5	45	12	14
			4.8	3.2	11.4	13.6	19.2	23.5	30.3	35.9	42.9			
	ECZ 2317 xx ECZ 2410 xx ECZ 2640 xx	3/8	5.6	4.0	15.3	18.3	25.9	31.7	40.9	48.4	57.9	48	14	19
			6.4		20.0	24.0	33.9	41.5	53.6	63.4	75.8			
			7.9		31.2	37.3	52.7	64.6	83.4	99.0	118			
	EDZ 2940 xx EDZ 3128 xx	1/2	9.5	3.3	45.6	54.5	77.1	94.4	122	144	172	64	18	22
			11.1	4.8	61.8	73.9	105	128	165	196	234			
	EEZ 3165 xx	3/4	12.7	4.7	79.7	95.3	135	165	213	252	301	70	19	27
			15.9	6.3	126	150	212	260	336	397	475			
	EFZ 3260 xx EFZ 3372 xx	1	15.9	6.3	126	150	212	260	336	397	475	92	25	36
			19.0		180	215	304	372	480	568	679			
	EHZ 3507 xx EHZ 3663 xx EHZ 3747 xx	1 1/2	22.2	7.9	245	293	414	507	655	774	926	111	27	50
25.4				320	383	541	663	856	1013	1210				
28.6				361	431	610	747	964	1141	1364				
EKZ 4109 xx EKZ 4139 xx	2	34.9	11.1	527	629	890	1090	1407	1665	1990	149	31	63	
		38.1		671	803	1136	1391	1796	2125	2540				



Operation with pressure values and capacities shown on the grey background recommended for cast or machined metal nozzles only.

Spiral nozzles can be delivered in brass and all the plastic materials in the following list. Most types are also available from stock or with short delivery in cast 316 stainless steel. Please contact our sales offices for delivery time in a given material.

Materials

B31	AISI 316L Stainless steel
D1	PVC
D2	Polypropylene
D8	PVDF
E1	PTFE
L8	Hastelloy C 276
T1	Brass

FULL CONE NOZZLES

E-X

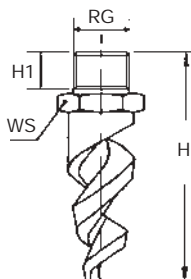

SPIRAL NOZZLES/WIDE PASSAGE

E-X type nozzles feature the same design and advantages as the E-type nozzles, while the resistance to clogging is enhanced by a longer spiral pitch. The spiral pitch length is typically equal to the inlet orifice diameter, therefore any foreign particle entering the nozzle can also find a way out through the spiral opening.

Material list at the bottom of previous page.

Code	RG inch	D mm	D1 mm	Capacity at different pressure values (lpm) (bar)								Dimensions mm			
				0.7	1.0	2.0	3.0	5.0	7.0	10	H	H1	WS		
120°															
ECW 2230 xx Xy	3/8	4.8	4.8	11.4	13.6	19.2	23.5	30.3	35.9	42.9	70	15	22		
ECW 2317 xx Xy		5.6	5.6	15.3	18.3	25.9	31.7	40.9	48.4	57.9					
ECW 2410 xx Xy		6.4	6.4	20.0	24.0	33.9	41.5	53.6	63.4	75.8					
ECW 2640 xx Xy		7.9	7.9	31.2	37.3	52.7	64.6	83.4	98.7	118					
EDW 2940 xx Xy	1/2	9.5	9.5	45.6	54.5	77.1	94.4	122	144	172	86	18	27		
EDW 3128 xx Xy		11.1	11.1	61.8	73.9	105	128	165	196	234					
EEW 3165 xx Xy	3/4	12.7	12.7	79.7	95.3	135	165	213	252	301	130	20	27		
EFW 3260 xx Xy	1	16.0	16.0	126	150	212	260	336	397	475	131	26	34		
EFW 3372 xx Xy		19.0	19.0	180	215	304	372	480	568	679	168	26	34		
EHW 3507 xx Xy	1 1/2	22.2	22.2	245	293	414	507	655	774	926	171	27	50		
EHW 3663 xx Xy		25.4	25.4	320	383	541	663	856	1013	1210					
EHW 3747 xx Xy		28.6	28.6	361	431	610	747	964	1141	1364	185	27	50		
EKW 4109 xx Xy	2	35.0	35.0	527	629	890	1090	1407	1665	1990	279	32	65		
EKW 4139 xx Xy		38.1	38.1	671	803	1136	1391	1796	2125	2540					
EMW 4204 xx Xy	3	44.5	44.5	985	1178	1666	2040	2634	3116	3725	267	32	90		
EMW 4265 xx Xy		51.0	51.0	1280	1530	2164	2650	3421	4048	4838					
EPW 4412 xx Xy	4	63.5	63.5	1990	2379	3364	4120	5318	6293	7522	293	36	127		

Operation with pressure values and capacities shown on the grey background recommended for cast or machined metal nozzles only.

Coding

Extra wide passage spiral nozzles are often supplied in a special design, where the nozzle has no thread and it is assembled onto a nipple by means of a retaining nut. This design is the only one possible with Silicon Carbide nozzles, while it can be obtained as an option for nozzles cast in special alloys or stainless steel.

To identify such nozzles please note the following coding

EHW 3747 xx Xy

xx = Material code, see material table on the previous page

y = Connection code / B=Bspt male thread / N=NPT male thread / F= Locknut fitting



SILICON CARBIDE NOZZLES

We design and supply spiral nozzles made out several types of silicon carbide, for applications where fluids containing abrasive solid particles must be sprayed and long nozzle service life is required.

Please contact our offices for more detailed information.

Common Applications

Chemical processes

Fire fighting

Gas cooling

Gas & smoke scrubbers

FLAT JET NOZZLES RANGE OVERVIEW

A complete range of flat jet spray nozzles is shown on the following pages.

Flat jet nozzles produce typically strong impact values, since the jet energy is concentrated over a limited surface.

Different techniques are available to produce a flat spray, each one offering specific design and spray properties so that it is possible to choose the one nozzle meeting all or most of the requirements for a given case.

For each nozzle type we show the most required construction materials but, as for all other nozzles, special materials for given applications are often available or can be quoted.

Because of the flat jet shape and its relatively high impact value these nozzles can be employed to wash objects moving on a conveyor in a transverse direction with regard to the pipe on which the nozzles are assembled.

Since a flat jet spraying system involves large or relatively large number of nozzles assembled onto one or more manifolds, a wide range of assembly accessories has been developed to make the job faster. Using a properly designed fitting not only makes for a professional look for a machine or a system, it also assures flat sprays to be properly aligned in the right flat jet orientation, or all of them being located at the right distance from the conveyor.

Recommended accessories are shown at the bottom of each Catalogue page.



Type	Connection	Properties	Application	Page
F	Thread, male/female	High impact	High pressure washing	28
GA	Thread, male	Parabolic distribution	General purpose	30
GX	Nut and nipple	Orientable flat jet	General purpose	31
GY	Nut and nipple	Fixed orientation	General purpose	34
HT	Quick connection	Fast replacement	General purpose	36
J	Thread, male	General purpose	General purpose	37
K	Thread, male	High impact	Low pressure washing	42
K	Thread male	Very wide angle	Washing, cooling	44

STRAIGHT JET NOZZLES

Some applications require nozzles producing a sharp straight jet for maximum impact. It is customary in the nozzle industry to consider straight jet nozzles as flat jet nozzles with a 0° spray angle. Straight jet nozzles are then shown in this Catalogue together with flat jet nozzles. All flat jet nozzle types are available as straight jet nozzles, except GY and K types, with the same materials used for flat jet nozzles.

FLAT JET NOZZLES

F

OUTER DIMENSIONS OF F TYPE NOZZLES AND FX NOZZLE TIPS

US Gals	PNR Code
02	1460
03	1686
04	1930
045	2103
05	2116
055	2126
06	2138
065	2149
07	2160
075	2170
08	2181
09	2204
10	2226
12	2272
12.5	2280
13	2296
15	2341
20	2456
30	2682

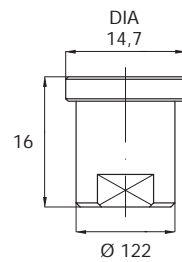

FX

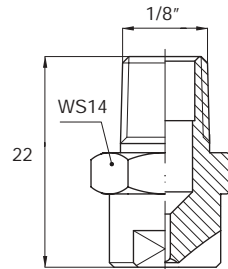

FA

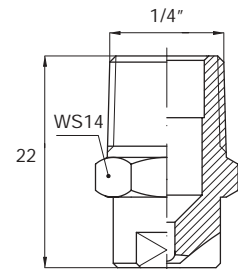

FB

High pressure washing accessories

We supply a range our range of quality guns and lances designed for high pressure washing applications in our Accessories Catalog CTG AC20.



UMW 0010 D4



UMW 0020 D4



UMW 0030 B3



UMW 0045 B3

Flow straightener

We can supply on request our FX tips complete with an inside stainless steel flow straightener to improve jet efficiency.



FLAT JET NOZZLES

GA

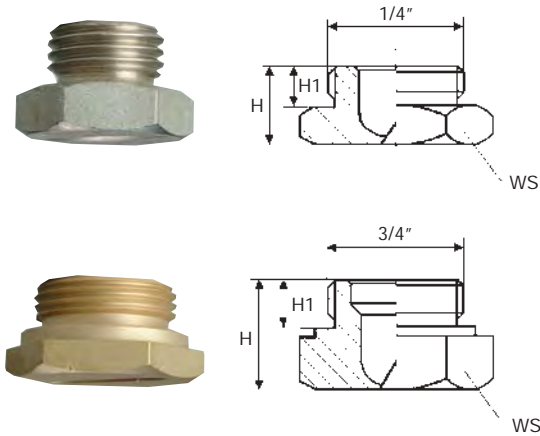

SHORT BODY

GA type nozzles deliver a flat jet spray with parabolic distribution pattern, which allows for obtaining an even distribution when several nozzles are assembled in a row onto a manifold. Their short body design makes it possible to use nozzle spray pipes in such machines or systems where the available space is very limited. GA nozzles are manufactured in two different capacity ranges out of brass or 303 stainless steel, and on request from a choice of additional metallic and plastic materials. Because of their limited length these nozzles can only be produced with a straight BSP thread, and require some extra care when being assembled to get the proper flat jet alignment. Also note the different dimensions given in the table below for nozzles manufactured out of plastic materials.

Materials	B1	AISI 303 Stainless steel
	B31	AISI 316L Stainless steel
	D1	PVC
	E1	PTFE, Teflon
	T1	Brass

1/4" BSP Thread

GAM 45°	GAQ 60°	GAU 90°	GAW 120°	Code	D mm	Capacity at different pressure values (lpm) (bar)									
						0.5	1.0	1.5	2.0	3.0	4.0	5.0	7.0	10	
	•	•	•	1310	2.0	1.27	1.79	2.19	2.53	3.10	3.58	4.00	4.74	5.66	
	•	•	•	1385	2.2	1.57	2.22	2.72	3.14	3.85	4.45	4.97	5.88	7.03	
•	•	•	•	1490	2.5	2.00	2.83	3.46	4.00	4.90	5.66	6.33	7.48	8.95	
•	•	•	•	1780	3.0	3.18	4.50	5.52	6.37	7.80	9.01	10.1	11.9	14.2	
•	•	•	•	2124	4.0	5.06	7.16	8.77	10.1	12.4	14.3	16.0	18.9	22.6	
•	•	•	•	2153	4.2	6.25	8.83	10.8	12.5	15.3	17.7	19.8	23.4	27.9	
•	•	•	•	2194	5.0	7.92	11.2	13.7	15.8	19.4	22.4	25.0	29.6	35.4	

3/4" BSP Thread

GAM 45°	GAQ 60°	GAU 90°	GAW 120°	Code	D mm	Capacity at different pressure values (lpm) (bar)									
						0.5	1.0	1.5	2.0	3.0	4.0	5.0	7.0	10	
	•	•	•	2195	5.0	7.96	11.3	13.8	15.9	19.5	22.5	25.2	29.8	35.6	
	•	•	•	2246	5.5	10.0	14.1	17.3	20.0	24.5	28.3	31.6	37.4	44.7	
	•	•	•	2311	6.0	12.7	17.9	21.9	25.3	31.0	35.8	40.0	47.4	56.6	
•	•	•	•	2490	8.0	20.0	28.2	34.6	40.0	49.0	56.6	63.3	74.8	89.5	
•	•	•	•	2610	9.0	24.9	35.2	43.1	49.8	61.0	70.4	78.8	93.2	111	
•	•	•	•	2760	10.0	31.0	43.8	53.7	62.1	76.0	87.8	98.1	116	139	

Dimensions of plastic nozzles

GA nozzles made out of plastic materials, have lower material strength and therefore different dimensions with a longer thread and a stronger front hexagon are utilized.



Dimensions mm	Small size			Large size		
Material	H	H1	WS	H	H1	WS
AISI 303	12	7	17	15	8	32
AISI 316L						
BRASS						
POLYPROPYLENE	17	7	17	23	11	32
PTFE						
PVC						

FLAT JET NOZZLE TIPS

GX

LOW CAPACITY

Flat jet nozzle tips are usually mounted onto a pipe by means of a welded nipple or a clamp, and secured in place with a retaining nut. Seals are available for higher pressure operation, see bottom of the page. They can be therefore easily replaced and the jet can be conveniently oriented in the desired direction.

The tip models shown in this page deliver very low flow values, the precision machined tiny orifices can be protected against the risk of plugging by means of a filter fitting inside our nipples and clamps which are designed for this purpose.

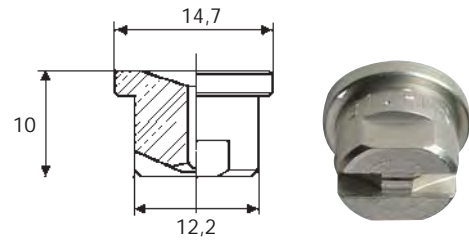

Materials	B1	AISI 303 Stainless steel
	B31	AISI 316L Stainless steel
	T1	Brass

GXD	GXL	GXN	GXR	Code	Capacity (lpm) at different pressure values (bar)									
					0.5	1.0	1.5	2.0	3.0	4.0	5.0	7.0	10	
			•	0060				0.05	0.06	0.07	0.08	0.09	0.11	
			•	0100				0.08	0.10	0.12	0.13	0.15	0.18	
			•	0130				0.11	0.13	0.15	0.17	0.20	0.24	
		•	•	0200		0.12	0.14	0.16	0.20	0.23	0.26	0.31	0.37	
	•	•	•	0260		0.15	0.18	0.21	0.26	0.30	0.34	0.40	0.47	
•	•	•	•	0390		0.23	0.28	0.32	0.39	0.45	0.50	0.60	0.71	
•	•	•	•	0590	0.24	0.34	0.42	0.48	0.59	0.68	0.76	0.90	1.08	
•	•	•	•	0780	0.32	0.45	0.55	0.64	0.78	0.90	1.01	1.19	1.42	
•	•	•	•	1120	0.49	0.69	0.85	0.98	1.20	1.39	1.55	1.83	2.19	
•	•	•	•	1160	0.65	0.92	1.13	1.31	1.60	1.85	2.07	2.44	2.92	

Accessories

All our range of accessories for GX tips, including welding nipples, pipe clamps, cartridge filters and retaining nuts are shown in our Accessories Catalog CTG AC20.

How to compose the nozzle code

The nozzles tips shown in this page can be supplied with eight different spray angles, whose value are indicated by the third digit in the nozzle code. Therefore the nozzle tip code has to be indicated as in the following example.

GXS 0260 T1

73°

GXS	GXT	GXV	GXJ	Code	0.5	1.0	1.5	2.0	3.0	4.0	5.0	7.0	10
•				0060				0.05	0.06	0.07	0.08	0.09	0.11
•				0100				0.08	0.10	0.12	0.13	0.15	0.18
•				0130				0.11	0.13	0.15	0.17	0.20	0.24
•	•	•		0150				0.13	0.15	0.17	0.20	0.25	0.28
•	•	•	•	0200		0.12	0.14	0.16	0.20	0.23	0.26	0.31	0.37
•	•	•	•	0260		0.15	0.18	0.21	0.26	0.30	0.34	0.40	0.47
•	•	•	•	0390		0.23	0.28	0.32	0.39	0.45	0.50	0.60	0.71
•	•	•	•	0590	0.24	0.34	0.42	0.48	0.59	0.68	0.76	0.90	1.08
•	•	•	•	0780	0.32	0.45	0.55	0.64	0.78	0.90	1.01	1.19	1.42
•	•	•	•	1120	0.49	0.69	0.85	0.98	1.20	1.39	1.55	1.83	2.19
•	•	•	•	1160	0.65	0.92	1.13	1.31	1.60	1.85	2.07	2.44	2.92

Spray angle codes

GXD	GXL	GXN	GXR	GXS	GXT	GXV	GXJ
25°	40°	50°	65°	73°	80°	95°	110°

Please note that following spray angle coding applies.

The table on the left shows the codes for the different spray angles.

Material Table

Material	0060	0100	0130	0150	0200	0260	0390	0590	0780	1120	1160
AISI 316L							•	•	•	•	•
AISI 303							•	•	•	•	•
Brass	•	•	•	•	•	•	•	•	•	•	•

Because of the extreme difficulty of working hard materials such as stainless steels with very small profile drills not all the capacity sizes shown in the nozzle table are available in all materials. The table below shows the minimum capacity values we can produce for each given material. Please contact our offices for information on the maximum spray angle available for each capacity and material.

Seal available on request

See seal code for standard tip dimension on page 33.

FLAT JET NOZZLE TIPS

GX

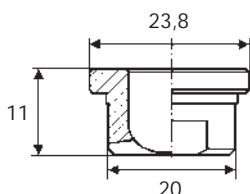
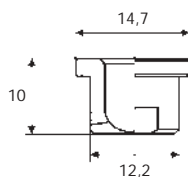

How to compose the nozzle code

The nozzle tips shown on this page can be supplied with six different spray angles, whose value is indicated by the third digit in the nozzle code.

Therefore, the nozzle tip code has to be identified as in the following example.

GXQ 1780 B31

60°

The codes for the different spray angle values are listed in the table adjacent.

STANDARD AND LARGE CAPACITIES

Flat jet nozzle tips are usually mounted onto a pipe by means of a welded 3/8" nipple or a clamp, and secured in place with a retaining nut. Seals are available for higher pressure operation, see bottom table next page. They can therefore easily be replaced and their jet can be conveniently oriented in the desired direction. The tip models shown on this page deliver the most popular capacity values, the precision machined orifices can be protected against the risk of plugging by means of a filter fitting inside the nipples and clamps, which are designed for this purpose. Higher capacity tips, shown in the bottom table, do not need filter protection because of the large dimension of the orifices and are assembled onto 3/4" nipples.

See nipple and retaining nut codes at the bottom of the page. Tips with higher capacities and larger dimensions than those shown in the Catalogue can be delivered on request, together with specification of the nipples and retaining nuts.

Materials	B1	AISI 303 Stainless steel
	B31	AISI 316L Stainless steel
	T1	Brass

Assembly fittings

The table in the following page shows the coding for a typical assembly of a nozzle tip, by means of a retaining nut and a welding nipple.

Threaded nipples, as well as a range of plastic or steel pipe clamps below, make it possible to choose the best suited solution and are also shown in our accessories Catalogue CTG AC20.

Spray angle codes

GXA	GXF	GXM	GXQ	GXU	GXW
0°	30°	45°	60°	90°	120°



Typical assembly with nipple and nut.

Assembly fittings

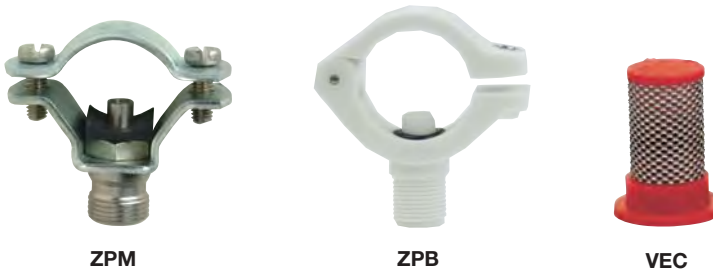

ZPM

ZPB

VEC

FLAT JET NOZZLE TIPS

GX

STANDARD AND LARGE CAPACITIES

Standard capacity tips

GXA	GXF	GXM	GXQ	GXU	GXW	Code	Capacity at different pressure values								(lpm)
															(bar)
							0.5	1.0	1.5	2.0	3.0	4.0	5.0	7.0	10
	•	•	•	•	•	1190	0.78	1.10	1.34	1.55	1.90	2.19	2.45	2.90	3.47
	•	•	•	•	•	1233	0.95	1.35	1.65	1.90	2.33	2.69	3.01	3.56	4.25
•	•	•	•	•	•	1310	1.27	1.79	2.19	2.53	3.10	3.58	4.00	4.74	5.66
•	•	•	•	•	•	1385	1.57	2.22	2.72	3.14	3.85	4.45	4.97	5.88	7.03
•	•	•	•	•	•	1490	2.00	2.83	3.46	4.00	4.90	5.66	6.33	7.48	8.95
•	•	•	•	•	•	1581	2.37	3.35	4.11	4.74	5.81	6.71	7.50	8.87	10.6
•	•	•	•	•	•	1780	3.18	4.50	5.52	6.37	7.80	9.01	10.1	11.9	14.2
•	•	•	•	•	•	1980	4.00	5.66	6.93	8.00	9.80	11.3	12.7	15.0	17.9
•	•	•	•	•	•	2124	5.06	5.85	8.77	10.1	12.4	14.3	16.0	18.9	22.6
	•	•	•	•	•	2153	6.25	7.20	10.8	12.5	15.3	17.7	19.8	23.4	27.9
	•	•	•	•	•	2194	7.96	9.20	13.8	15.9	19.5	22.5	25.2	29.8	35.6
	•	•	•	•	•	2245	10.0	11.5	17.3	20.0	24.5	28.3	31.6	37.4	44.7

Large capacity tips

GXA	GXF	GXM	GXQ	GXU	GXW	Code	Capacity at different pressure values								(lpm)
															(bar)
							0.5	1.0	1.5	2.0	3.0	4.0	5.0	7.0	10
	•	•	•	•	•	1781	3.18	4.50	5.52	6.37	7.80	9.01	10.1	11.9	14.2
	•	•	•	•	•	1981	4.00	5.66	6.93	8.00	9.80	11.3	12.7	15.0	17.9
•	•	•	•	•	•	2125	5.06	7.16	8.77	10.1	12.4	14.3	16.0	18.9	22.6
•	•	•	•	•	•	2154	6.25	8.83	10.8	12.5	15.3	17.7	19.8	23.4	27.9
•	•	•	•	•	•	2195	7.92	11.2	13.7	15.8	19.4	22.4	25.0	29.6	35.4
•	•	•	•	•	•	2246	10.0	14.1	17.3	20.0	24.5	28.3	31.6	37.4	44.7
•	•	•	•	•	•	2311	12.7	17.9	21.9	25.3	31.0	35.8	40.0	47.4	56.6
•	•	•	•	•	•	2490	20.0	28.3	34.6	40.0	49.0	56.6	63.3	74.8	89.5
•	•	•	•	•	•	2610	24.9	35.2	43.1	49.8	61.0	70.4	78.8	93.2	111
	•	•	•	•	•	2760	31.0	43.9	53.7	62.1	76.0	87.8	98.1	116	139
	•	•	•	•	•	3122	49.8	70.4	86.3	99.6	122	141	158	186	223

Assembly fittings coding

Size	Locknut	Welding nipple	Male nipple	Seal
Standard size 3/8"	VAA 0038 xx	ZAA 1738 xx	ZHA 3838 xx	VDA 0038 P7
Large size 3/4"	VAA 0075 xx	ZAA 2775 xx	ZHA 7575 xx	VDA 0075 P7

DOVETAIL FLAT JET TIPS

GY

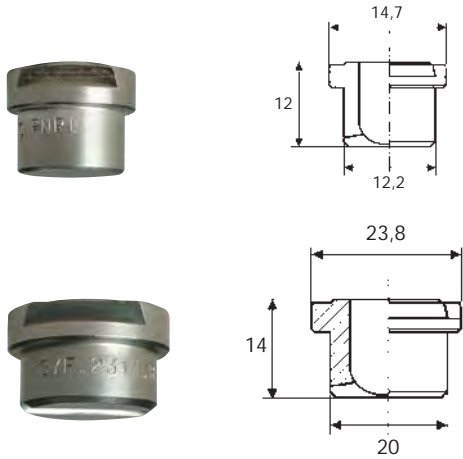

STANDARD AND LARGE CAPACITIES

GY flat jet nozzle tips are usually mounted onto a pipe by means of a welded nipple, and secured in place with a retaining nut. They can therefore easily be replaced and their dovetail connection assures precise assembly at all times, since the nozzle can be assembled only when the flat jet is properly oriented. The tip models shown on this page deliver the most popular capacity values, while larger capacities and sizes can be manufactured on request, and delivered complete with matching nipple and retaining nuts.

The two sizes shown are to be assembled onto 3/8" and 3/4" nipples, see nipple and retaining nut codes at the bottom of the next page.

Materials	B1	AISI 303 Stainless steel
	B31	AISI 316L Stainless steel
	T1	Brass

How to compose the nozzle code

The nozzle tips shown on this page can be supplied with six different spray angles, whose value is indicated by the third digit in the nozzle code. Therefore, the nozzle tip code has to be identified as in the following example.

GYQ 1780 B31



Codes for the different spray angles are listed in the table adjacent.

Dovetail nipples

GY type tips are assembled onto their own series of matching dovetail nipples, to assure perfect alignment: the two tip sizes require nipples and caps as shown in the table below.

Please note that the right flat jet orientation with jets inclined so as not to disturb each other is automatically obtained welding the nipples in place with their dovetail aligned along the pipe axis.

This is easily done by running a straight rule across the dovetail profile machined on the nipple.

Spray angle codes

GYA	GYF	GYM	GYQ	GYU	GYW
0°	30°	45°	60°	90°	120°



Typical assembly with dovetail nipple and nut.

Welding nipples

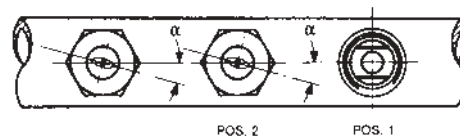

See values for jet deviation angle (α) beside capacity tables next page.

DOVETAIL FLAT JET TIPS

GY

STANDARD AND LARGE CAPACITIES

Standard capacity tips

Jet deviation angle $\alpha = 5^\circ$

GYF	GYM	GYQ	GYU	GYW	Code	Capacity at different pressure values								
						(lpm) (bar)								
						0.5	1.0	1.5	2.0	3.0	4.0	5.0	7.0	10
•	•	•	•	•	1190	0.78	1.10	1.34	1.55	1.90	2.19	2.45	2.90	3.47
•	•	•	•	•	1233	0.95	1.35	1.65	1.90	2.33	2.69	3.01	3.56	4.25
•	•	•	•	•	1310	1.27	1.79	2.19	2.53	3.10	3.58	4.00	4.74	5.66
•	•	•	•	•	1385	1.57	2.22	2.72	3.14	3.85	4.45	4.97	5.88	7.03
•	•	•	•	•	1490	2.00	2.83	3.46	4.00	4.90	5.66	6.33	7.48	8.95
•	•	•	•	•	1581	2.37	3.35	4.11	4.74	5.81	6.71	7.50	8.87	10.6
•	•	•	•	•	1780	3.18	4.50	5.52	6.37	7.80	9.01	10.1	11.9	14.2
•	•	•	•	•	1980	4.00	5.66	6.93	8.00	9.80	11.3	12.7	15.0	17.9
•	•	•	•	•	2124	5.06	5.85	8.77	10.1	12.4	14.3	16.0	18.9	22.6
•	•	•	•	•	2153	6.25	7.20	10.8	12.5	15.3	17.7	19.8	23.4	27.9
•	•	•	•	•	2194	7.96	9.20	13.8	15.9	19.5	22.5	25.2	29.8	35.6

Large capacity tips

Jet deviation angle $\alpha = 15^\circ$

GYA	GYF	GYM	GYQ	GYU	GYW	Code	Capacity at different pressure values								
							(lpm) (bar)								
							0.5	1.0	1.5	2.0	3.0	4.0	5.0	7.0	10
	•	•	•	•	•	1781	3.18	4.50	5.52	6.37	7.80	9.01	10.1	11.9	14.2
	•	•	•	•	•	1981	4.00	5.66	6.93	8.00	9.80	11.3	12.7	15.0	17.9
•	•	•	•	•	•	2125	5.06	7.16	8.77	10.1	12.4	14.3	16.0	18.9	22.6
•	•	•	•	•	•	2154	6.25	8.83	10.8	12.5	15.3	17.7	19.8	23.4	27.9
•	•	•	•	•	•	2195	7.92	11.2	13.7	15.8	19.4	22.4	25.0	29.6	35.4
•	•	•	•	•	•	2246	10.0	14.1	17.3	20.0	24.5	28.3	31.6	37.4	44.7
•	•	•	•	•	•	2311	12.7	17.9	21.9	25.3	31.0	35.8	40.0	47.4	56.6
•	•	•	•	•	•	2490	20.0	28.3	34.6	40.0	49.0	56.6	63.3	74.8	89.5
•	•	•	•	•	•	2610	24.9	35.2	43.1	49.8	61.0	70.4	78.8	93.2	111
		•	•	•	•	2760	31.0	43.9	53.7	62.1	76.0	87.8	98.1	116	139
		•	•			3122	49.8	70.4	86.3	99.6	122	141	158	186	223

Assembly fittings coding

Size	Locknut	Welding nipple
Standard size 3/8"	VAA 0040 xx	ZAC 1738 xx
Large size 3/4"	VAA 0075 xx	ZAC 2775 xx

QUICK-CONNECT NOZZLES

HT

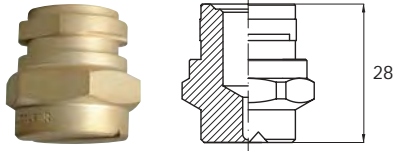
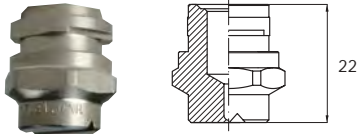

STANDARD AND LARGE CAPACITY

Flat jets of the HT series offer the same quality and specifications as our standard nozzle types, with the additional convenience of a bayonet coupling which allows not only for a simple assembly without any tool being required but also for automatic spray pattern alignment. The optimum performance of your system or machine is then conveniently safeguarded, with a noticeable reduction in service cost and production loss for system downtime .

We offer capacities from 3.1 to 78 lpm over the standard range of spray angles, and a matching range of male, female or welding nipples.

- Materials
- B1 AISI 303 Stainless steel
 - B3 AISI 316 Stainless steel
 - T1 Brass

Standard capacity tips

HTA 0°	HTL 40°	HTN 50°	HTR 65°	HTV 95°	HTJ 110°	Code	Capacity at different pressure values (lpm) (bar)									
							0.5	1.0	1.5	2.0	3.0	4.0	5.0	7.0	10	
•	•	•	•	•	•	1310	1.27	1.79	2.19	2.53	3.10	3.58	4.00	4.74	5.66	
•	•	•	•	•	•	1385	1.57	2.22	2.72	3.14	3.85	4.45	4.97	5.88	7.03	
•	•	•	•	•	•	1490	2.00	2.83	3.46	4.00	4.90	5.66	6.33	7.48	8.95	
•	•	•	•	•	•	1581	2.37	3.35	4.11	4.74	5.81	6.71	7.50	8.87	10.6	
•	•	•	•	•	•	1780	3.18	4.50	5.52	6.37	7.80	9.01	10.1	11.9	14.2	
•	•	•	•	•	•	1980	4.00	5.66	6.93	8.00	9.80	11.3	12.7	15.0	17.9	
•	•	•	•	•	•	2124	5.06	5.85	8.77	10.1	12.4	14.3	16.0	18.9	22.6	
•	•	•	•	•	•	2153	6.25	7.20	10.8	12.5	15.3	17.7	19.8	23.4	27.9	
•	•	•	•	•	•	2194	7.96	9.20	13.8	15.9	19.5	22.5	25.2	29.8	35.6	

Large capacity tips

HTA 0°	HTL 40°	HTN 50°	HTR 65°	HTV 95°	HTJ 110°	Code	Capacity at different pressure values (lpm) (bar)									
							0.5	1.0	1.5	2.0	3.0	4.0	5.0	7.0	10	
•	•	•	•	•	•	2310	12.7	17.9	21.9	25.3	31.0	35.8	40.0	47.4	56.6	
•	•	•	•	•	•	2390	15.9	22.5	27.6	31.8	39.0	45.0	50.3	59.6	71.2	
•	•	•	•	•	•	2470	19.2	27.1	33.2	38.4	47.0	54.3	60.7	71.8	85.8	
•	•	•	•	•	•	2590	24.1	34.1	41.7	48.2	59.0	68.1	76.2	90.1	108	
•	•	•	•	•	•	2780	22.5	45.0	55.2	63.7	78.0	90.1	101	119	142	

Ordering Codes

	Thread size inch	Standard size	Large size	H mm	WS mm	D mm
Male nipple	1/4	ZHS 0025 xx		29	22	
	3/8	ZHS 0038 xx		29	22	
	1/2		ZHS 0050 xx	35	30	
Female nipple	3/8	ZHT 0038 xx		29	22	
Welding nipple		ZHU 0038 xx	ZHU 0050 xx	32		28
Seal (Viton) for SS nipples	All	VDH 0026 E7	VDH 0050 E7			
Seal (BUNA) for brass nipples	All	VDH 0026 E8	VDH 0050 E8			

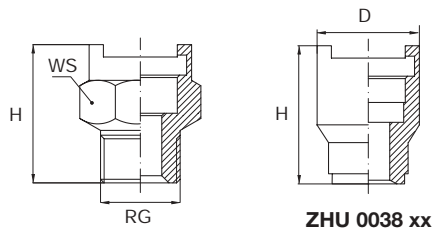

ZHS 0025 xx

ZHS 0050 xx

ZHU 0038 xx

FLAT JET NOZZLES

J

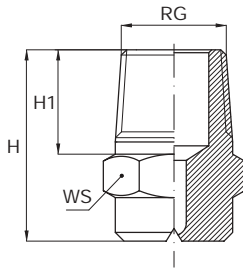

STANDARD CAPACITY TYPES

The standard model flat jet nozzles are available in a very wide range of capacities, spray angles and materials. The connection thread is tapered in order to easily allow for both a tight connection and a correct spray pattern orientation. Nozzles shown on this page cover the standard capacity range from 1.5 to 47 litres per minute, delivering high impact jets with small/medium size droplets for the flat spray patterns. Capacity tables also include straight jet types, with spray angle value shown as 0°. They can be made on request out of any machineable material, in addition to the standard materials shown below.

Materials	B1	AISI 303 Stainless steel
	B3	AISI 316 Stainless steel
	T1	Brass

Spray angle codes

JBA	JBC	JBF	JBM	JBQ	JBU	JBW
0°	20°	30°	45°	60°	90°	120°

Thread size code (RG)

JA	JB	JC
1/8"	1/4"	3/8"

How to compose the nozzle code

The nozzles shown on this page can be supplied with seven different spray angles, whose value is indicated by the third digit in the nozzle code. Therefore, the nozzle tip code has to be identified as in the following example.

JBQ 1780 B3

60°

Codes for the different spray angles are listed in the table adjacent.

Spray Angle	JAA	JBA	JCA	Code	Capacity at different pressure values								(lpm) (bar)
					0.5	1.0	2.0	3.0	4.0	5.0	7.0	10	
0°	•	•		1153	0.62	0.88	1.25	1.53	1.77	1.98	2.34	2.79	3.95
	•	•		1190	0.78	1.10	1.55	1.90	2.19	2.45	2.90	3.47	4.91
	•	•		1233	0.95	1.35	1.90	2.33	2.69	3.01	3.56	4.25	6.02
	•	•		1310	1.27	1.79	2.53	3.10	3.58	4.00	4.74	5.66	8.00
	•	•		1385	1.57	2.22	3.14	3.85	4.45	4.97	5.88	7.03	9.94
	•	•		1490	2.00	2.83	4.00	4.90	5.66	6.33	7.48	8.95	12.6
	•	•		1581	2.37	3.35	4.74	5.81	6.71	7.50	8.87	10.6	15.0
	•	•	•	1780	3.18	4.50	6.37	7.80	9.01	10.1	11.9	14.2	20.1
	•	•	•	1980	4.00	5.66	8.00	9.80	11.3	12.7	15.0	17.9	25.3
	•	•	•	2124	5.06	7.16	10.1	12.4	14.3	16.0	18.9	22.6	32.0
	•	•	•	2153	6.25	8.83	12.5	15.3	17.7	19.8	23.4	27.9	39.5
	•	•	•	2195	7.96	11.3	15.9	19.5	22.5	25.2	29.8	35.6	50.3
	•	•	•	2245	10.0	14.1	20.0	24.5	28.3	31.6	37.4	44.7	63.3
	•	•	•	2274	11.2	15.8	22.4	27.4	31.6	35.4	41.9	50.0	70.7
	•	•	•	2310	12.7	17.9	25.3	31.0	35.8	40.0	47.4	56.6	80.0
•	•	•	2390	15.9	22.5	31.8	39.0	45.0	50.3	59.6	71.2	100	
•	•	•	2470	19.2	27.1	38.4	47.0	54.3	60.7	71.8	85.8	121	

Dimensions and weights

Code	Size	H	H1	WS	W
	inch	mm	mm	mm	gram
JA	1/8	19.5	11	12	9
JB	1/4	22	12	14	18
JC	3/8	25	14	17	34

FLAT JET NOZZLES

J

STANDARD CAPACITY TYPES

	JAC	JBC	JCC	Code	Capacity at different pressure values								(lpm)
					0.5	1.0	2.0	3.0	4.0	5.0	7.0	10	20
20°	•			1153	0.62	0.88	1.25	1.53	1.77	1.98	2.34	2.79	3.95
	•			1190	0.78	1.10	1.55	1.90	2.19	2.45	2.90	3.47	4.91
	•			1233	0.95	1.35	1.90	2.33	2.69	3.01	3.56	4.25	6.02
	•			1310	1.27	1.79	2.53	3.10	3.58	4.00	4.74	5.66	8.00
	•	•		1385	1.57	2.22	3.14	3.85	4.45	4.97	5.88	7.03	9.94
	•	•		1490	2.00	2.83	4.00	4.90	5.66	6.33	7.48	8.95	12.6
	•	•		1581	2.37	3.35	4.74	5.81	6.71	7.50	8.87	10.6	15.0
			•	1780	3.18	4.50	6.37	7.80	9.01	10.1	11.9	14.2	20.1
			•	1980	4.00	5.66	8.00	9.80	11.3	12.7	15.0	17.9	25.3
			•	2124	5.06	7.16	10.1	12.4	14.3	16.0	18.9	22.6	32.0
			•	2153	6.25	8.83	12.5	15.3	17.7	19.8	23.4	27.9	39.5
			•	2195	7.96	11.3	15.9	19.5	22.5	25.2	29.8	35.6	50.3
			•	2245	10.0	14.1	20.0	24.5	28.3	31.6	37.4	44.7	63.3
			•	2274	11.2	15.8	22.4	27.4	31.6	35.4	41.9	50.0	70.7

	JAF	JBF	JCF	Code	0.5	1.0	2.0	3.0	4.0	5.0	7.0	10	20
30°	•			1153	0.62	0.88	1.25	1.53	1.77	1.98	2.34	2.79	3.95
	•			1190	0.78	1.10	1.55	1.90	2.19	2.45	2.90	3.47	4.91
	•			1233	0.95	1.35	1.90	2.33	2.69	3.01	3.56	4.25	6.02
	•	•		1310	1.27	1.79	2.53	3.10	3.58	4.00	4.74	5.66	8.00
	•	•		1385	1.57	2.22	3.14	3.85	4.45	4.97	5.88	7.03	9.94
	•	•		1490	2.00	2.83	4.00	4.90	5.66	6.33	7.48	8.95	12.6
	•	•		1581	2.37	3.35	4.74	5.81	6.71	7.50	8.87	10.6	15.0
			•	1780	3.18	4.50	6.37	7.80	9.01	10.1	11.9	14.2	20.1
			•	1980	4.00	5.66	8.00	9.80	11.3	12.7	15.0	17.9	25.3
			•	2124	5.06	7.16	10.1	12.4	14.3	16.0	18.9	22.6	32.0
			•	2153	6.25	8.83	12.5	15.3	17.7	19.8	23.4	27.9	39.5
			•	2195	7.96	11.3	15.9	19.5	22.5	25.2	29.8	35.6	50.3
			•	2245	10.0	14.1	20.0	24.5	28.3	31.6	37.4	44.7	63.3
			•	2274	11.2	15.8	22.4	27.4	31.6	35.4	41.9	50.0	70.7

	JAM	JBM	JCM	Code	0.5	1.0	2.0	3.0	4.0	5.0	7.0	10	20
45°	•			1153	0.62	0.88	1.25	1.53	1.77	1.98	2.34	2.79	3.95
	•			1190	0.78	1.10	1.55	1.90	2.19	2.45	2.90	3.47	4.91
	•			1233	0.95	1.35	1.90	2.33	2.69	3.01	3.56	4.25	6.02
	•	•		1310	1.27	1.79	2.53	3.10	3.58	4.00	4.74	5.66	8.00
	•	•		1385	1.57	2.22	3.14	3.85	4.45	4.97	5.88	7.03	9.94
	•	•		1490	2.00	2.83	4.00	4.90	5.66	6.33	7.48	8.95	12.6
	•	•		1581	2.37	3.35	4.74	5.81	6.71	7.50	8.87	10.6	15.0
			•	1780	3.18	4.50	6.37	7.80	9.01	10.1	11.9	14.2	20.1
			•	1980	4.00	5.66	8.00	9.80	11.3	12.7	15.0	17.9	25.3
			•	2124	5.06	7.16	10.1	12.4	14.3	16.0	18.9	22.6	32.0
			•	2153	6.25	8.83	12.5	15.3	17.7	19.8	23.4	27.9	39.5
			•	2195	7.96	11.3	15.9	19.5	22.5	25.2	29.8	35.6	50.3
			•	2245	10.0	14.1	20.0	24.5	28.3	31.6	37.4	44.7	63.3
			•	2274	11.2	15.8	22.4	27.4	31.6	35.4	41.9	50.0	70.7

Spray angle codes

JBA	JBC	JBF	JBM	JBQ	JBU	JBW
0°	20°	30°	45°	60°	90°	120°

Thread size code (RG)

JA	JB	JC
1/8"	1/4"	3/8"

FLAT JET NOZZLES

J

How to compose the nozzle code

The nozzles shown on this page can be supplied with seven different spray angles, whose value is indicated by the third digit in the nozzle code. Therefore, the nozzle tip code has to be identified as in the following example.

JBQ 1780 B3

60°

Codes for the different spray angles are listed in the table at the bottom of the page.

STANDARD CAPACITY TYPES

	JAQ	JBQ	JCQ	Code	Capacity at different pressure values								(lpm) (bar)	
					0.5	1.0	2.0	3.0	4.0	5.0	7.0	10	20	
					60°	•	•		1153	0.62	0.88	1.25	1.53	1.77
	•	•		1190	0.78	1.10	1.55	1.90	2.19	2.45	2.90	3.47	4.91	
	•	•		1233	0.95	1.35	1.90	2.33	2.69	3.01	3.56	4.25	6.02	
	•	•		1310	1.27	1.79	2.53	3.10	3.58	4.00	4.74	5.66	8.00	
	•	•		1385	1.57	2.22	3.14	3.85	4.45	4.97	5.88	7.03	9.94	
	•	•	•	1490	2.00	2.83	4.00	4.90	5.66	6.33	7.48	8.95	12.6	
	•	•	•	1581	2.37	3.35	4.74	5.81	6.71	7.50	8.87	10.6	15.0	
		•	•	1780	3.18	4.50	6.37	7.80	9.01	10.1	11.9	14.2	20.1	
		•	•	1980	4.00	5.66	8.00	9.80	11.3	12.7	15.0	17.9	25.3	
		•	•	2124	5.06	7.16	10.1	12.4	14.3	16.0	18.9	22.6	32.0	
		•	•	2153	6.25	8.83	12.5	15.3	17.7	19.8	23.4	27.9	39.5	
		•	•	2195	7.96	11.3	15.9	19.5	22.5	25.2	29.8	35.6	50.3	
		•	•	2245	10.0	14.1	20.0	24.5	28.3	31.6	37.4	44.7	63.3	
		•	•	2274	11.2	15.8	22.4	27.4	31.6	35.4	41.9	50.0	70.7	
			•	2310	12.7	17.9	25.3	31.0	35.8	40.0	47.4	56.6	80.0	
			•	2390	15.9	22.5	31.8	39.0	45.0	50.3	59.6	71.2	100	
			•	2470	19.2	27.1	38.4	47.0	54.3	60.7	71.8	85.8	121	

	JAU	JBU	JCU	Code	0.5	1.0	2.0	3.0	4.0	5.0	7.0	10	20
90°	•			1153	0.62	0.88	1.25	1.53	1.77	1.98	2.34	2.79	3.95
	•			1190	0.78	1.10	1.55	1.90	2.19	2.45	2.90	3.47	4.91
	•			1233	0.95	1.35	1.90	2.33	2.69	3.01	3.56	4.25	6.02
	•	•		1310	1.27	1.79	2.53	3.10	3.58	4.00	4.74	5.66	8.00
	•	•		1385	1.57	2.22	3.14	3.85	4.45	4.97	5.88	7.03	9.94
	•	•		1490	2.00	2.83	4.00	4.90	5.66	6.33	7.48	8.95	12.6
	•	•	•	1581	2.37	3.35	4.74	5.81	6.71	7.50	8.87	10.6	15.0
	•	•	•	1780	3.18	4.50	6.37	7.80	9.01	10.1	11.9	14.2	20.1
		•	•	1980	4.00	5.66	8.00	9.80	11.3	12.7	15.0	17.9	25.3
		•	•	2124	5.06	7.16	10.1	12.4	14.3	16.0	18.9	22.6	32.0
		•	•	2153	6.25	8.83	12.5	15.3	17.7	19.8	23.4	27.9	39.5
		•	•	2195	7.96	11.3	15.9	19.5	22.5	25.2	29.8	35.6	50.3
		•	•	2245	10.0	14.1	20.0	24.5	28.3	31.6	37.4	44.7	63.3
		•	•	2274	11.2	15.8	22.4	27.4	31.6	35.4	41.9	50.0	70.7
			•	2310	12.7	17.9	25.3	31.0	35.8	40.0	47.4	56.6	80.0
			•	2390	15.9	22.5	31.8	39.0	45.0	50.3	59.6	71.2	100
			•	2470	19.2	27.1	38.4	47.0	54.3	60.7	71.8	85.8	121

	JAW	JBW	JCW	Code	0.5	1.0	2.0	3.0	4.0	5.0	7.0	10	20
120°	•			1153	0.62	0.88	1.25	1.53	1.77	1.98	2.34	2.79	3.95
	•			1190	0.78	1.10	1.55	1.90	2.19	2.45	2.90	3.47	4.91
	•	•		1233	0.95	1.35	1.90	2.33	2.69	3.01	3.56	4.25	6.02
	•	•		1310	1.27	1.79	2.53	3.10	3.58	4.00	4.74	5.66	8.00
	•	•	•	1385	1.57	2.22	3.14	3.85	4.45	4.97	5.88	7.03	9.94
	•	•	•	1490	2.00	2.83	4.00	4.90	5.66	6.33	7.48	8.95	12.6
	•	•	•	1581	2.37	3.35	4.74	5.81	6.71	7.50	8.87	10.6	15.0
	•	•	•	1780	3.18	4.50	6.37	7.80	9.01	10.1	11.9	14.2	20.1
	•	•	•	1980	4.00	5.66	8.00	9.80	11.3	12.7	15.0	17.9	25.3
		•	•	2124	5.06	7.16	10.1	12.4	14.3	16.0	18.9	22.6	32.0
		•	•	2153	6.25	8.83	12.5	15.3	17.7	19.8	23.4	27.9	39.5
		•	•	2195	7.96	11.3	15.9	19.5	22.5	25.2	29.8	35.6	50.3
		•	•	2245	10.0	14.1	20.0	24.5	28.3	31.6	37.4	44.7	63.3
			•	2274	11.2	15.8	22.4	27.4	31.6	35.4	41.9	50.0	70.7
			•	2310	12.7	17.9	25.3	31.0	35.8	40.0	47.4	56.6	80.0
			•	2390	15.9	22.5	31.8	39.0	45.0	50.3	59.6	71.2	100
			•	2470	19.2	27.1	38.4	47.0	54.3	60.7	71.8	85.8	121

Spray angle codes

JBA	JBC	JBF	JBM	JBQ	JBU	JBW
0°	20°	30°	45°	60°	90°	120°

Thread size code (RG)

JA	JB	JC
1/8"	1/4"	3/8"

FLAT JET NOZZLES

J

LARGE CAPACITY TYPES

The standard model flat jet nozzles are available in a very wide range of capacities, spray angles and materials. The connection thread is tapered in order to easily allow for both a tight connection and a correct spray pattern orientation. Nozzles shown on this page cover the standard capacity range from 59 to 435 litres per minute, delivering high impact jets with medium size droplets and with flat spray patterns. Capacity tables also include straight jet types, with spray angle value shown as 0°. They can be made on request out of any machineable material, in addition to the standard materials shown below.

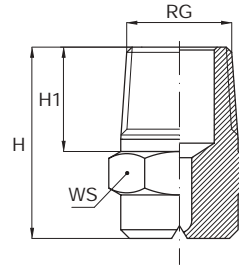

- Materials B1 AISI 303 Stainless steel
 B3 AISI 316 Stainless steel
 T1 Brass

Spray angle codes

JDA	0°
JDB	15°
JDD	25°
JDL	40°
JDN	50°
JDR	65°
JDT	80°
JDV	95°

Dimensions and weights

Code	JD	JE	JF
Size inch	1/2	3/4	1
H mm	33	41	61
H1 mm	17	20	22
WS mm	22	27	27
W grams	65	130	215

Spray Angle	1/2"	3/4"	1"	Code	Capacity at different pressure values								(lpm)		
					0.5	1.0	2.0	3.0	4.0	5.0	7.0	10	20	(bar)	
0°	• •	• •	• •	JDA 2590 xx	24.1	34.1	48.2	59.0	68.1	76.2	90.1	108	152		
				JDA 2780 xx	31.8	45.0	63.7	78.0	90.1	101	119	142	201		
				JEA 3134 xx	54.7	77.4	109	134	155	173	205	245	346		
				JEA 3275 xx	112	159	225	275	318	355	420	502	710		
				JFA 3390 xx	159	225	318	390	450	503	596	712	1007		
				JFA 3435 xx	178	251	355	435	502	562	664	794	1123		
15°	• • •	•		JDB 2195 xx	7.96	11.3	15.9	19.5	22.5	25.2	29.8	35.6	50.3		
				JDB 2274 xx	11.2	15.8	22.4	27.4	31.6	35.4	41.9	50.0	70.7		
				JDB 2390 xx	15.9	22.5	31.8	39.0	45.0	50.3	59.6	71.2	101		
				JEB 2990 xx	40.4	57.2	80.8	99.0	114	128	151	181	256		
25°	• • •	•	•	JDD 2390 xx	15.9	22.5	31.8	39.0	45.0	50.3	59.6	71.2	101		
				JDD 2590 xx	24.1	34.1	48.2	59.0	68.1	76.2	90.1	108	152		
				JDD 2780 xx	31.8	45.0	63.7	78.0	90.1	101	119	142	201		
				JFD 3195 xx	79.6	113	159	195	225	252	298	356	503		
40°	• • • • •	•	•	JDL 2195 xx	7.96	11.3	15.9	19.5	22.5	25.2	29.8	35.6	50.3		
				JDL 2240 xx	9.80	13.9	19.6	24.0	27.7	31.0	36.7	43.8	62.0		
				JDL 2274 xx	11.2	15.8	22.4	27.4	31.6	35.4	41.9	50.0	70.7		
				JDL 2390 xx	15.9	22.5	31.8	39.0	45.0	50.3	59.6	71.2	101		
				JDL 2590 xx	24.1	34.1	48.2	59.0	68.1	76.2	90.1	108	152		
				JDN 2274 xx	11.2	15.8	22.4	27.4	31.6	35.4	41.9	50.0	70.7		
50°	• • • • •	•	•	JDN 2390 xx	15.9	22.5	31.8	39.0	45.0	50.3	59.6	71.2	101		
				JDN 2590 xx	24.1	34.1	48.2	59.0	68.1	76.2	90.1	108	152		
				JDN 2780 xx	31.8	45.0	63.7	78.0	90.1	101	119	142	201		
				JEN 3158 xx	64.5	91.2	129	158	182	204	241	288	408		
				JFN 3195 xx	79.6	113	159	195	225	252	298	356	503		
				JFN 3230 xx	93.9	133	188	230	266	297	351	420	594		
65°	• • • • •	•	•	JDR 2195 xx	7.96	11.3	15.9	19.5	22.5	25.2	29.8	35.6	50.3		
				JDR 2240 xx	9.80	13.9	19.6	24.0	27.7	31.0	36.7	43.8	62.0		
				JDR 2274 xx	11.2	15.8	22.4	27.4	31.6	35.4	41.9	50.0	70.7		
				JDR 2390 xx	15.9	22.5	31.8	39.0	45.0	50.3	59.6	71.2	101		
				JDR 2590 xx	24.1	34.1	48.2	59.0	68.1	76.2	90.1	108	152		
				JFR 2780 xx	31.8	45.0	63.7	78.0	90.1	101	119	142	201		
80°	• • • • • •	•	•	JDT 2195 xx	7.96	11.3	15.9	19.5	22.5	25.2	29.8	35.6	50.3		
				JDT 2240 xx	9.80	13.9	19.6	24.0	27.7	31.0	36.7	43.8	62.0		
				JDT 2274 xx	11.2	15.8	22.4	27.4	31.6	35.4	41.9	50.0	70.7		
				JDT 2390 xx	15.9	22.5	31.8	39.0	45.0	50.3	59.6	71.2	101		
				JDT 2590 xx	24.1	34.1	48.2	59.0	68.1	76.2	90.1	108	152		
				JDT 2780 xx	31.8	45.0	63.7	78.0	90.1	101	119	142	201		
				JET 2780 xx	31.8	45.0	63.7	78.0	90.1	101	119	142	201		
				JET 3158 xx	64.5	91.2	129	158	182	204	241	288	408		
95°	• • • • •	•	•	JDV 2195 xx	7.96	11.3	15.9	19.5	22.5	25.2	29.8	35.6	50.3		
				JDV 2240 xx	9.80	13.9	19.6	24.0	27.7	31.0	36.7	43.8	62.0		
				JDV 2274 xx	11.2	15.8	22.4	27.4	31.6	35.4	41.9	50.0	70.7		
				JDV 2390 xx	15.9	22.5	31.8	39.0	45.0	50.3	59.6	71.2	101		
				JDV 2590 xx	24.1	34.1	48.2	59.0	68.1	76.2	90.1	108	152		

FLAT JET NOZZLES

K

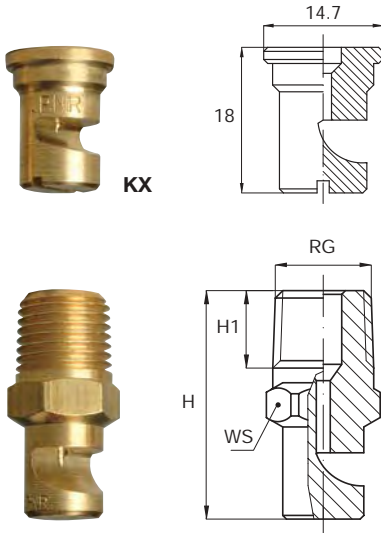

LARGE SPRAY ANGLE

K flat jet nozzles work on the deflection principle conveying a water vein onto a machined deflection surface, and produce a jet with a wide angle flat spray pattern, medium impact value and medium size droplets.

Their round outlet orifice and unobstructed inside passage minimize plugging risks.

K style nozzles shown on the next page are available with a threaded connection and, for capacity sizes from 0390 to 2310 also as a nozzle tip for assembly onto a nipple by means of a retaining nut.

Materials	B1	AISI 303 Stainless steel
	B3	AISI 316 Stainless steel
	T1	Brass

Thread size and dimensions

Code	RG inch	H mm	H1 mm	WS mm
KGW	1/8	31	10	14
KHW	1/4	34	12.5	14
KIW	3/8	44	13	17
KJW	1/2	49	17	22
KKW	3/4	65	20	36
KLW	1	92	26	46

How to compose the nozzle code

The nozzle shown on the next page can be supplied with same capacity and with different connection threads, the size is indicated by the second digit in the nozzle code. Therefore, the nozzle code has to be identified as in the following example.

KJW 2470 B3

|
1/2"

Nozzle dimensions

Some nozzles may have different dimensions even when made with the same thread.

Dimensions given above refer always to the largest nozzle with a given thread size.

Please refer to our offices for detailed information.

Typical applications

- Washing of fruits, vegetables, crushed stones and any other product moving on a conveyor.
- Cooling and washing of vertical surfaces and also for fire fighting purposes.

FLAT JET NOZZLES

K

LARGE SPRAY ANGLE

KGW	KHW	KIW	KJW	KKW	KLW	KXW	D mm	Code	Capacity at different pressure values							Spray angle at press (bar)	
									(lpm)	(bar)						1.5	4.0
									0.5	1.0	2.0	3.0	4.0	5.0	7.0	1.5	4.0
•						•	0.6	0390	0.16	0.23	0.32	0.39	0.45	0.50	0.60	90	120
•						•	0.7	0590	0.24	0.34	0.48	0.59	0.68	0.76	0.90	105	120
•						•	0.8	0780	0.32	0.45	0.64	0.78	0.90	1.01	1.19	110	125
•						•	1.0	1120	0.49	0.69	0.98	1.20	1.39	1.55	1.83	105	122
•	•					•	1.1	1160	0.65	0.92	1.31	1.60	1.85	2.07	2.44	110	130
•	•					•	1.3	1200	0.82	1.15	1.63	2.00	2.31	2.58	3.06	120	130
•	•					•	1.4	1230	0.94	1.33	1.88	2.30	2.66	2.97	3.51	110	125
•	•					•	1.6	1310	1.27	1.79	2.53	3.10	3.58	4.00	4.74	120	130
•	•					•	1.8	1390	1.59	2.25	3.18	3.90	4.50	5.03	5.96	130	140
•	•					•	2.3	1590	2.41	3.41	4.82	5.90	6.81	7.62	9.01	120	130
•	•					•	2.6	1780	3.18	4.50	6.37	7.80	9.01	10.1	11.9	130	140
•	•					•	2.9	1940	3.84	5.43	7.68	9.40	10.9	12.1	14.4	140	150
•	•					•	3.3	2117	4.78	6.75	9.55	11.7	13.5	15.1	17.9	110	120
•	•					•	3.6	2141	5.76	8.14	11.5	14.1	16.3	18.2	21.5	120	130
•	•					•	3.8	2157	6.41	9.06	12.8	15.7	18.1	20.3	24.0	120	130
•	•					•	4.0	2172	7.02	9.93	14.0	17.2	19.9	22.2	26.3	125	135
•	•					•	4.1	2188	7.68	10.9	15.4	18.8	21.7	24.3	28.7	130	140
•	•					•	4.4	2210	8.57	12.1	17.1	21.0	24.2	27.1	32.1	135	145
•	•	•				•	4.5	2230	9.39	13.3	18.8	23.0	26.6	29.7	35.1	110	120
•	•	•				•	5.0	2270	11.0	15.6	22.0	27.0	31.2	34.9	41.2	115	125
•	•	•	•			•	5.3	2310	12.7	17.9	25.3	31.0	35.8	40.0	47.4	125	135
•	•	•	•			•	5.6	2350	14.3	20.2	28.6	35.0	40.4	45.2	53.5	130	140
•	•	•	•			•	6.0	2390	15.9	22.5	31.8	39.0	45.0	50.3	59.6	130	140
•	•	•	•			•	6.5	2470	19.2	27.1	38.4	47.0	54.3	60.7	71.8	135	140
•	•	•	•			•	7.1	2550	22.5	31.8	44.9	55.0	63.5	71.0	84.0	135	145
•	•	•	•			•	7.5	2630	25.7	36.4	51.4	63.0	72.7	81.3	96.2	140	150
•	•	•	•	•		•	8.0	2700	28.6	40.4	57.2	70.0	80.8	90.4	107	130	140
•	•	•	•	•		•	8.4	2780	31.8	45.0	63.7	78.0	90.1	101	119	135	145
•	•	•	•	•		•	8.7	2860	35.1	49.7	70.2	86.0	99.3	111	131	135	145
•	•	•	•	•		•	9.3	2940	38.4	54.3	76.8	94.0	109	121	144	140	150
•	•	•	•	•		•	10.3	3110	44.9	63.5	89.8	110	127	142	168	125	135
•	•	•	•	•		•	11.0	3125	51.0	72.2	102	125	144	161	191	130	135
•	•	•	•	•		•	11.4	3141	57.6	81.4	115	141	163	182	215	130	135
•	•	•	•	•		•	12.2	3164	67.0	94.7	134	164	189	212	251	135	145
•	•	•	•	•	•	•	14.6	3235	95.9	136	192	235	271	303	359	130	135
•	•	•	•	•	•	•	17.9	3350	143	202	286	350	404	452	535	130	135



ZAA 1738 xx



VAA 0038 xx

Assembly accessories

KXW tips are normally secured with a retaining nut onto a welded nipple.

All details on accessories are shown in our Catalogue CTG AC20.

FLAT JET NOZZLES

K

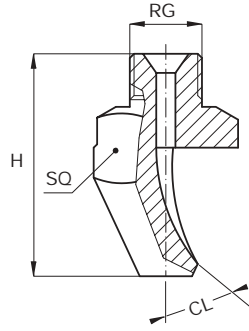

HIGH IMPACT TYPES

K flat jet nozzles work on the deflection principle conveying a water vein onto a deflection surface designed to produce a narrow jet with flat spray pattern, high impact value and medium size droplets.

Their round outlet orifice and unobstructed inside passages minimize plugging risks.

K style nozzles shown in this page are available with a threaded connection and, for the capacity sizes shown in the table, with a quick coupling connection for assembly onto the matching quick connection nipple.

Materials	B1	AISI 303 Stainless steel
	B3	AISI 316 Stainless steel
	T1	Brass

Thread size code

KOx	1/8"
KPx	1/4"
KQx	3/8"
KRx	1/2"
KSx	3/4"
KTx	QC

How to compose the nozzle code

The nozzle shown on this page can be supplied with same capacity and a different connection thread, the size is indicated by the second digit in the nozzle code. Therefore, the nozzle code has to be identified as in the following example.

KQB 2195 B3
|
3/8"

Quick coupling nipples

	Thread size inch	Standard size	Large size	H mm	WS mm	D mm
Male nipple	1/4	ZHS 0025 xx		29	22	
	3/8	ZHS 0038 xx		29	22	
	1/2		ZHS 0050 xx	35	30	
Female nipple	3/8	ZHT 0038 xx		29	22	
Welding nipple		ZHU 0038 xx	ZHU 0050 xx	32		28
Seal (Viton) for SS nipples	All	VDH 0026 E7	VDH 0050 E7			
Seal (BUNA) for brass nipples	All	VDH 0026 E8	VDH 0050 E8			

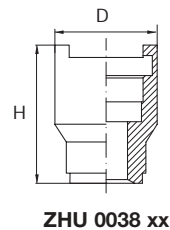
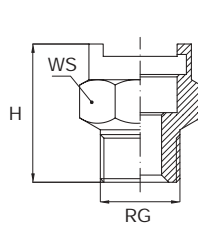

FLAT JET NOZZLES

K

HIGH IMPACT TYPES

	1/8"	1/4"	3/8"	1/2"	3/4"	QC	Code	DIA mm	Capacity at different pressure values						lpm bar	CL deg	H mm	SQ mm	
									2.0	3.0	4.0	5.0	6.0	7.0					10
									15°		KPB KPB	KQB KQB KQB	KRB KRB KRB	KSB					
25°		KPD					2156	3.7	12.7	15.6	18.0	20.1	22.1	23.8	28.5	25	65	20	
35°	KOH	KPH KPH	KQH KQH KQH KQH KQH	KRH KRH KRH	KSH	KTH KTH	1160 1390 1780 1980 2117 2156 2195 2230 2310 2390 2630 2780	1.2 1.9 2.6 2.9 3.3 3.7 4.1 4.5 5.3 5.9 7.5 8.4	1.31 3.18 6.37 8.00 9.55 12.7 15.6 15.9 18.8 25.3 51.4 63.7	1.60 3.90 7.80 9.80 11.7 15.6 19.5 23.0 31.0 63.0	1.85 4.50 9.01 11.3 13.5 18.0 22.5 26.6 35.8 72.7	2.07 5.03 10.1 12.7 15.1 20.1 25.2 29.7 40.4 81.3	2.26 5.52 11.0 13.9 16.5 22.1 27.6 32.5 43.8 89.1	2.44 5.96 11.9 17.9 21.4 23.8 29.8 35.1 59.6 96.2	2.92 7.12 14.2 17.9 21.4 28.5 35.6 42.0 71.2 115	40 36 30 28 28 26 22 24 19 23	23 37 43 49 52 58 64 73 81 89 114	12 15 20 20 25 26 25 32	
40°			KQL KQL KQL KQL KQL KQL				2156 2195 2230 2270 2310 2350 2390	3.7 4.1 4.5 5.0 5.2 5.7 6.0	12.7 15.9 18.8 22.0 25.3 28.6 31.8	15.6 19.5 23.0 27.0 31.0 35.0 39.0	18.0 22.5 26.6 31.2 35.8 40.4 45.0	20.1 25.2 29.7 34.9 40.0 45.2 50.3	22.1 27.6 32.5 38.2 43.8 49.5 55.2	23.8 29.8 35.1 41.2 47.4 53.5 59.6	28.5 35.6 42.0 49.3 56.6 63.9 71.2	35 33 33 29 26 28 28	60 64 72 75 77 77 87	25	
50°		KPN KPN KPN	KQN KQN KQN KQN KQN KQN KQN				1390 1980 2156 2230 2390 2490 2630 2780	1.9 2.9 3.7 4.5 6.0 6.7 7.5 8.4	3.18 8.00 12.7 18.8 31.8 40.0 51.4 63.7	3.90 9.80 15.6 23.0 39.0 49.0 63.0	4.50 11.3 18.0 26.6 45.0 56.6 72.7	5.03 12.7 20.1 29.7 50.3 63.3 81.3	5.52 13.9 22.1 32.5 55.2 69.3 89.1	5.96 15.0 23.8 35.1 59.6 74.8 96.2	7.12 17.9 28.5 42.0 71.2 89.5 115	60 42 45 37 40 38 37 32	31 41 47 55 72 72 72 72	15 20 25 30	

Nozzle dimensions

Some nozzles may have different dimensions even when made with the same thread.

Dimensions given above refer always to the largest nozzle with a given thread size.

Please refer to our offices for detailed information.

Typical Applications

- Washing of fruits, vegetables, crushed stones and any other product moving on a conveyor.
- High pressure cleaning processes
- Felt washing in paper making machines.

HOLLOW CONE NOZZLES RANGE OVERVIEW

Hollow cone nozzles produce a conical spray pattern, where drops are distributed onto the outer surface of the conical shape. They are used in many different applications, typically creating a droplet curtain inside a cylindrical tower for applications like smoke scrubbing, dedusting and cooling or to cool wide surfaces like the outside of LPG storage tanks.

Our range of hollow cone nozzles is shown on the following pages, and additional information about the different types and designs of hollow cone nozzles can be found on page 4 in this Catalogue. The table below lists the different types available, and gives basic information about their specific features, so as to make the choice easier for a given application.

Accessories available for each nozzle type are usually shown on the single Catalog pages.

Three basic types of hollow cone nozzles are available, that is:

- Turbulence nozzles, tangential spray.
Conical spray pattern axis at 90° with respect to feed pipe axis.
Offer small size droplets, standard and wide angles (very wide angles on request).
- Turbulence nozzles, in line spray.
Conical spray pattern in line with the feed pipe axis.
General specifications similar to off-line types.
- Deflection nozzles, in line spray.
Conical spray pattern in line with feed pipe axis.
Highest resistance to clogging.



All nozzle types, with the exception of turbulence types, do not need any inside part or vane to produce the spray pattern, and are therefore relatively resistant to clogging dangers.

Type	Connection	Specifications	Applications	Page
Turbulence nozzles, tangential				
PA / PB	Female thread	Forged / Cast	General purpose	47
PE / PF	Female / Male thread	Machined from bar stock	General purpose	48
PN / PO	Female / Male thread	Moulded plastic	General purpose	50
Turbulence nozzles, axial				
RA	Female thread	Fine spray, small passages	Humidification	51
RB	Male thread	Fine spray, clog resistant	Dust control	52
RX / RZ	Male thread	Low and very low capacity	Humidification	54
Deflection nozzles, axial				
RC	Male thread	Extra wide spray angle	Dust control	53

HOLLOW CONE NOZZLES

PA/PB

TANGENTIAL NOZZLES

PA type nozzles produce a hollow cone jet working on the tangential flow principle, with a nominal spray angle of 90° and form a ring shaped impact area. The nozzle has no internal vane and the centrifugal force inside the whirl chamber provides the energy to break up the liquid being sprayed. The narrowest section through the nozzle is normally the water inlet diameter for standard angle nozzles (shown as DE in the table below), and the outlet orifice for the wide angle nozzles (shown as DU) these nozzles offer a remarkable resistance to clogging and avoid costly downtime for dismantling and cleaning operations. Sizes up to 3/4" are made out of a drop-forged body, with an upper cover for nozzle cleaning. Sizes from 1" and bigger are machined from a one piece casting.

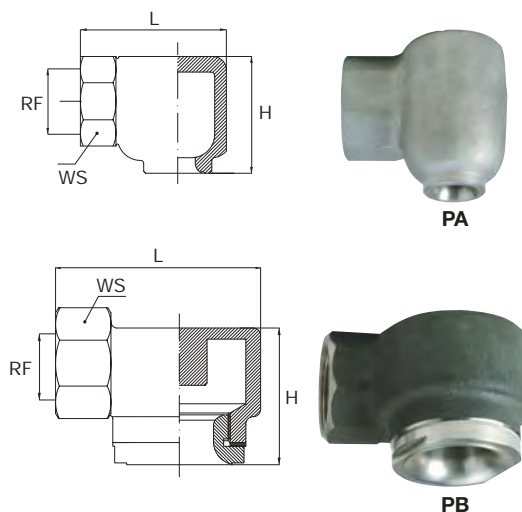

Materials B31 AISI 316 L Stainless steel
T1 Brass

70°	Code	RF inch	DE mm	DU mm	Capacity at different pressure values								Dimensions mm			
					0.3	0.5	0.7	1.0	2.0	3.0	5.0	7.0	10	H	L	WS
70°	PAS 1170 xx	3/8	3.5	2.0		0.69	0.72	0.98	1.39	1.70	2.19	2.60	3.10	27	37	22
90°	PAU 1390 xx	3/8	4.0	3.8	1.23	1.59	1.88	2.25	3.18	3.90	5.03	5.96	7.12	38	46	27
	PAU 1670 xx	1/2	5.6	5.2	2.12	2.74	3.24	3.87	5.47	6.70	8.65	10.2	12.2			
	PAU 1850 xx		5.7	6.0	2.69	3.47	4.11	4.91	6.94	8.50	11.0	13.0	15.5			
	PAU 2115 xx	3/4	6.6	6.9	3.64	4.69	5.56	6.64	9.39	11.5	14.8	17.6	21.0	48	60	36
	PAU 2220 xx		8.5	9.0	6.96	8.98	10.6	12.7	18.0	22.0	28.4	33.6	40.2			
	PAU 2320 xx		9.5	11.5	10.1	13.1	15.5	18.5	26.1	32.0	41.3	48.9	58.4			
	PAU 2420 xx	1	9.6	14.0	13.3	17.1	20.3	24.2	34.3	42.0	54.2	64.2	76.7	60	75	46
	PAU 2730 xx		20x10	13.7	23.1	29.8	35.3	42.1	59.6	73.0	94.2	112	133			
	PAU 2970 xx		16.5	30.7	39.6	46.9	56.0	79.2	97.0	125	148	177				
	PAU 3147 xx	1+1/2	32x16	19.5	46.5	60.0	71.0	84.9	120	147	190	225	268	90	93	60
	PAU 3194 xx			22.0	61.3	79.2	93.7	112	158	194	250	296	354			
	PAU 3244 xx	2	35x20	26.5	77.2	99.6	118	141	199	244	315	373	445	127	117	80
PAU 3294 xx	28.5			93.0	120	142	170	240	294	380	449	537				
PAU 3364 xx	2+1/2	40x40	29.5	115	149	176	210	297	364	470	556	665	156	140	100	
PAU 3490 xx			36.5	155	200	237	283	400	490	633	748	895				
PAU 3605 xx			45.0	191	247	292	349	494	605	781	924	1105				
130°	PBY 1390 xx	3/8	3.5	4.5		1.59	1.88	2.25	3.18	3.90	5.03	5.96	7.12	27	37	22
	PBY 1850 xx	1/2	4.4	7.5	2.69	3.47	4.11	4.91	6.94	8.50	11.0	13.0	15.5	35	46	27
	PBY 1980 xx		4.0	12	3.10	4.00	4.73	5.66	8.00	9.80	12.7	15.0	17.9			
	PBY 2128 xx	3/4	4.7	12	4.05	5.23	6.18	7.39	10.5	12.8	16.5	19.6	23.4	50	60	36
	PBY 2208 xx		6.5	12	6.58	8.49	10.0	12.0	17.0	20.8	26.9	31.6	38.0			
	PBY 2220 xx		6.1	15	6.96	8.98	10.6	12.7	18.0	22.0	28.4	33.6	40.2			
	PBY 2320 xx	1	6.5	19	10.1	13.1	15.5	18.5	26.1	32.0	41.3	48.9	58.4	60	93	47
	PBY 2420 xx		8.0	19	13.3	17.1	20.3	24.2	34.3	42.0	54.2	64.2	76.7			
	PBY 2730 xx		13.4	26	23.1	29.8	35.3	42.1	59.6	73.0	94.2	112	133			
	PBY 2970 xx	1+1/2	14.0	26	30.7	39.6	46.9	56.0	79.2	97.0	125	148	177	75	111	60
	PBY 3147 xx		15.0	37	46.5	60.0	71.0	84.9	120	147	190	225	268			
	PBY 3194 xx	2	19.5	37	61.3	79.2	93.7	112	158	194	250	296	354	91	140	75
	PBY 3244 xx		22.0	45	77.2	99.6	118	141	199	244	315	373	445			
	PBY 3294 xx	2+1/2	27.1	45	93.0	120	142	170	240	294	380	449	537	128	193	90
	PBY 3364 xx		25.5	64	115	149	176	210	297	364	470	556	665			
	PBY 3490 xx		33.0	64	155	200	237	283	400	490	633	748	895			
PBY 3605 xx	43.0	38.0	64	191	247	292	349	494	605	781	924	1105				
PBY 3665 xx		43.0	64	210	271	321	384	543	665	858	1016	1214				

Material table	3/8"	1/2"	3/4"	1"	1+1/2"	2"	2+1/2"
AISI 316L				•	•	•	•
Brass	•	•	•	•			

HOLLOW CONE NOZZLES

PE/PF



PE

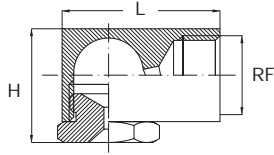

PF

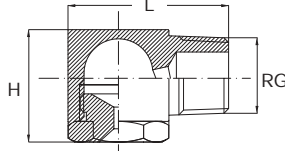

PT

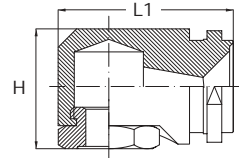

STANDARD ANGLE SPRAY NOZZLES

These hollow cone nozzles work on the tangential flow principle and are manufactured by machine tool operation from metal bar stock. This offers versatile construction of small and lesser sized nozzles. In addition nozzles can be made on request from any special materials and alloys that are available as a bar stock.

Materials	B1	AISI 303 Stainless steel
	B3	AISI 316 Stainless steel
	T1	Brass

Standard spray angle

50°	RF	PEN	PFN	PTN	Code	DE	DU	Capacity at different pressure values (lpm)								Dimensions mm		
	RG							0.5	0.7	1.0	2.0	3.0	5.0	7.0	10	H	L	L1
	inch					mm	mm											
	3/8		•	•	2180	8.0	6.1	7.35	8.69	10.4	14.7	18.0	23.2	27.5	32.9	24	34	35
			•	•	2220	7.7	7.0	8.98	10.6	12.7	18.0	22.0	28.4	33.6	40.2			
			•	•	2390	9.5	9.0	15.9	18.8	22.5	31.8	39.0	50.3	59.6	71.2			

70°	RF	PES	PFS	PTS	Code	DE	DU	0.5	0.7	1.0	2.0	3.0	5.0	7.0	10	H	L	L1
1/8			•		0390	0.9	1.0	0.16	0.19	0.23	0.32	0.39	0.50	0.60	0.71	19	24	26
					0780	1.4	1.7	0.32	0.38	0.45	0.64	0.78	1.01	1.19	1.42			
					1160	2.2	2.1	0.65	0.77	0.92	1.31	1.60	2.07	2.44	2.92			
					1230	2.5	2.7	0.94	1.11	1.33	1.88	2.30	2.97	3.51	4.20			
					1390	3.4	3.1	1.59	1.88	2.25	3.18	3.90	5.03	5.96	7.12			
					1630	4.0	3.9	2.57	3.04	3.64	5.14	6.30	8.13	9.62	11.5			
1/4		•	•	•	0781	1.1	1.6	0.32	0.38	0.45	0.64	0.78	1.01	1.19	1.42	23	32	32
					1161	2.1	2.5	0.65	0.77	0.92	1.31	1.60	2.07	2.44	2.92			
					1231	2.6	2.8	0.94	1.11	1.33	1.88	2.30	2.97	3.51	4.20			
					1391	3.5	3.4	1.59	1.88	2.25	3.18	3.90	5.03	5.96	7.12			
					1631	4.6	4.3	2.57	3.04	3.64	5.14	6.30	8.13	9.62	11.5			
					1781	4.4	4.8	3.18	3.77	4.50	6.37	7.80	10.1	11.9	14.2			
3/8		•	•	•	1392	3.7	3.5	1.59	1.88	2.25	3.18	3.90	5.03	5.96	7.12	24	34	35
					1632	4.5	4.2	2.57	3.04	3.64	5.14	6.30	8.13	9.62	11.5			
					1782	5.0	4.5	3.18	3.77	4.50	6.37	7.80	10.1	11.9	14.2			
					2118	5.8	5.6	4.78	5.65	6.75	9.55	11.7	15.1	17.9	21.4			
					2157	6.7	6.2	6.41	7.58	9.06	12.8	15.7	20.3	24.0	28.7			
					2196	7.5	6.7	8.00	9.47	11.3	16.0	19.6	25.3	29.9	35.8			
1/2		•	•	•	2230	8.3	7.9	9.39	11.1	13.3	18.8	23.0	29.7	35.1	42.0	31	50	50
					2197	9.5	6.4	8.00	9.47	11.3	16.0	19.6	25.3	29.9	35.8			
					2231	9.5	7.5	9.39	11.1	13.3	18.8	23.0	29.7	35.1	42.0			
					2310	9.5	9.0	12.7	15.0	17.9	25.3	31.0	40.0	47.4	56.6			
					2391	9.5	10.5	15.9	18.8	22.5	31.8	39.0	50.3	59.6	71.2			
					2470	10.0	12.0	19.2	22.7	27.1	38.4	47.0	60.7	71.8	85.8			
3/4		•	•	•	2311	9.5	9.0	12.7	15.0	17.9	25.3	31.0	40.0	47.4	56.6	39	55	58
					2392	10.7	9.7	15.9	18.8	22.5	31.8	39.0	50.3	59.6	71.2			
					2471	11.7	10.8	19.2	22.7	27.1	38.4	47.0	60.7	71.8	85.8			
					2550	11.7	12.0	22.5	26.6	31.8	44.9	55.0	71.0	84.0	100			
					2630	12.2	12.0	25.7	30.4	36.4	51.4	63.0	81.3	96.2	115			
					2700	12.7	12.0	28.6	33.8	40.4	57.2	70.0	90.4	107	128			
					2780	12.7	14.0	31.8	37.7	45.0	63.7	78.0	101	119	142			
					2860	12.7	16.1	35.1	41.5	49.7	70.2	86.0	111	131	157			
					2940	13.5	16.5	38.4	45.4	54.3	76.8	94.0	121	144	172			

HOLLOW CONE NOZZLES

PE/PF

WIDE ANGLE SPRAY NOZZLES

Wide spray angle

120°	RF RG inch	PEW	PFW	PTW	Code	DE mm	DU mm	Capacity at different pressure values								Dimensions mm										
								(lpm) (bar)								H	L	L1								
								0.5	0.7	1.0	2.0	3.0	5.0	7.0	10											
1/8	• • • • • • • • • • • •	•	•		0390	09	1.1	0.16	0.19	0.23	0.32	0.39	0.50	0.60	0.71	19	24	26								
					0780	1.4	1.5	0.32	0.38	0.45	0.64	0.78	1.01	1.19	1.42											
					1200	1.5	3.9	0.82	0.97	1.15	1.63	2.00	2.58	3.06	3.65											
					1230	2.0	3.4	0.94	1.11	1.33	1.88	2.30	2.97	3.51	4.20											
					1270	2.2	3.8	1.10	1.30	1.56	2.20	2.70	3.49	4.12	4.93											
					1320	2.1	4.5	1.31	1.55	1.85	2.61	3.20	4.13	4.89	5.84											
					1390	3.6	3.1	1.59	1.88	2.25	3.18	3.90	5.03	5.96	7.12											
					1510	3.4	5.0	2.08	2.46	2.94	4.16	5.10	6.58	7.79	9.31											
					1700	4.5	5.2	2.86	3.38	4.04	5.72	7.00	9.04	10.7	12.8											
					1/4	• • • • • • • • • • • •	•	•	•	0781	1.4	1.5	0.32	0.38	0.45				0.64	0.78	1.01	1.19	1.42	23	32	32
										1130	1.4	3.6	0.53	0.63	0.75				1.06	1.30	1.68	1.99	2.37			
										1160	1.4	4.0	0.65	0.77	0.92				1.31	1.60	2.07	2.44	2.92			
1190	2.0	2.3	0.78	0.92						1.10	1.55	1.90	2.48	2.90	3.50											
1271	2.2	3.8	1.10	1.30						1.56	2.20	2.70	3.49	4.12	4.93											
1321	2.2	4.5	1.31	1.55						1.85	2.61	3.20	4.13	4.89	5.84											
1391	3.6	3.1	1.59	1.88						2.25	3.18	3.90	5.03	5.96	7.12											
1511	3.4	5.0	2.08	2.46						2.94	4.16	5.10	6.58	7.79	9.31											
1600	3.4	5.2	2.45	2.90						3.46	4.90	6.00	7.75	9.17	11.0											
1701	4.2	5.2	2.86	3.38						4.04	5.72	7.00	9.04	10.7	12.8											
1780	3.7	6.0	3.18	3.77						4.50	6.37	7.80	10.1	11.9	14.2											
1860	4.0	5.6	3.51	4.15						4.97	7.02	8.60	11.1	13.1	15.7											
1940	5.0	5.7	3.84	4.54	5.43	7.68	9.40	12.1	14.4	17.2																
2117	5.8	2.4	4.78	5.65	6.75	9.55	11.7	15.1	17.9	21.4																
3/8	• • • • • • • • • • • •	•	•		1512	3.5	5.0	2.08	2.46	2.94	4.16	5.10	6.58	7.79	9.31	24	34	35								
					1601	3.5	5.2	2.45	2.90	3.46	4.90	6.00	7.75	9.17	11.0											
					1702	4.2	5.2	2.86	3.38	4.04	5.72	7.00	9.04	10.7	12.8											
					1781	3.7	6.0	3.18	3.77	4.50	6.37	7.80	10.1	11.9	14.2											
					1861	4.0	5.6	3.51	4.15	4.97	7.02	8.60	11.1	13.1	15.7											
					1941	5.0	5.7	3.84	4.54	5.43	7.68	9.40	12.1	14.4	17.2											
					2102	4.5	6.9	4.16	4.93	5.89	8.33	10.2	13.2	15.6	19.0											
					2110	5.0	6.2	4.49	5.31	6.35	8.98	11.0	14.2	16.8	20.0											
					2118	5.0	6.7	4.78	5.65	6.75	9.55	11.7	15.1	17.9	21.4											
					2133	6.1	8.0	5.43	6.42	7.68	10.9	13.3	17.2	20.3	24.3											
					2157	5.0	9.0	6.41	7.58	9.06	12.8	15.7	20.3	24.0	28.7											
					2172	6.2	7.5	7.02	8.31	9.93	14.0	17.2	22.2	26.3	31.4											
2196	6.2	8.4	8.00	9.47	11.3	16.0	19.6	25.3	29.9	35.8																
2220	6.2	9.7	8.98	10.6	12.7	18.0	22.0	28.4	33.6	40.2																
1/2		•	•		2391	9.0	10.5	15.9	18.8	22.5	31.8	39.0	50.3	59.6	71.2	31	50	50								
3/4		•			2630	10.3	15.0	25.7	30.4	36.4	51.4	63.0	81.3	96.2	115	39	55	58								

Pipe clamp

Our Accessories Catalogue (CTG AC20) shows several types of pipe clamps allowing for an easy assembly of hollow cone nozzles onto a pipe manifold.



ZPM

HOLLOW CONE NOZZLES

PN/PO

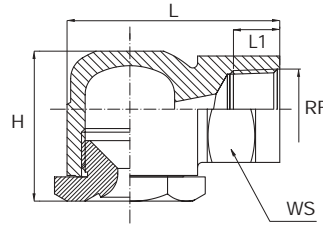

MOULDED PLASTIC NOZZLES

This range of hollow cone nozzles are made by plastic moulding, out of top quality glassfiber reinforced polypropylene with good mechanical strength and dimensional stability.

They produce small droplets, uniform distribution and are corrosion resistant: prices are moderate and are ideal for applications like air humidification, intensive product cooling and gas washing. Together with our pipe clamps, they offer the best solution in all cases where large quantity of nozzles have to be easily assembled onto pipe manifolds.

Maximum operating temperature 75° C.

Materials D6 Fiberglass reinforced PP

Angle	RF RG inch	PNS	POS	Code	DE mm	DU mm	Capacity at different pressure values (lpm) (bar)								Dimensions mm				
							0.5	0.7	1.0	2.0	3.0	5.0	7.0	10	H	L	L1	WS	
70°	3/8	•	•	1170	2.0	2.9	0.69	0.82	0.98	1.39	1.70	2.19	2.60	3.10	31	44	20	22	
80°	3/8	•	•	1260	2.7	3.5	1.06	1.26	1.50	2.12	2.60	3.36	3.97	4.75	31	44	20	22	
90°	3/8	•	•	1390	3.7	3.8	1.59	1.88	2.25	3.18	3.90	5.03	5.96	7.12	31	44	20	22	
				1670	4.4	5.2	2.74	3.24	3.87	5.47	6.70	8.65	10.2	12.2					
				1850	5.2	5.6	3.47	4.11	4.91	6.94	8.50	11.0	13.0	15.5					
				2115	6.1	6.3	4.69	5.56	6.64	9.39	11.5	14.8	17.6	21.0					
				2220	7.2	9.2	8.98	10.6	12.7	18.0	22.0	28.4	33.6	40.2					
90°	1/2	•	•	2320	9.5	10.5	13.1	15.5	18.5	26.1	32.0	41.3	48.9	58.4	42	55	35	30	
				2398	8.5	14.0	16.2	19.2	23.0	32.5	39.8	51.4	60.8	72.7					
130°	3/8	•	•	1170	1.7	3.5	0.69	0.82	0.98	1.39	1.70	2.19	2.60	3.10	31	44	20	22	
				1260	1.9	5.0	1.06	1.26	1.50	2.12	2.60	3.36	3.97	4.75					
				1390	2.7	5.0	1.59	1.88	2.25	3.18	3.90	5.03	5.96	7.12					
				1460	3.1	5.0	1.88	2.22	2.66	3.76	4.60	5.94	7.03	8.40					
				1570	3.0	7.5	2.33	2.75	3.29	4.65	5.70	7.36	8.71	10.4					
				1670	3.4	7.5	2.74	3.24	3.87	5.47	6.70	8.65	10.2	12.2					
				1850	4.1	7.5	3.47	4.11	4.91	6.94	8.50	11.0	13.0	15.5					
				1980	3.6	12	4.00	4.73	5.66	8.00	9.80	12.7	15.0	17.9					
				2128	4.2	12	5.23	6.18	7.39	10.5	12.8	16.5	19.6	23.4					
				2208	6.0	12	8.49	10.0	12.0	17.0	20.8	26.9	31.8	38.0					
	2220	6.4	12	8.98	10.6	12.7	18.0	22.0	28.4	33.6	40.2								
	130°	1/2	•	•	2129	4.3	14	5.23	6.18	7.39	10.5	12.8	16.5	19.6	23.4	42	55	35	30
					2209	5.8	14	8.49	10.0	12.0	17.0	20.8	26.9	31.8	38.0				
					2221	6.3	14	8.98	10.6	12.7	18.0	22.0	28.4	33.6	40.2				
					2320	7.6	14	13.1	15.5	18.5	26.1	32.0	41.3	48.9	58.4				
2420					9.0	14	17.1	20.3	24.2	34.3	42.0	54.2	64.2	76.7					



PO Male thread nozzles

For all 3/8" size nozzles we can supply PO type nozzles with 3/8" male thread.

HOLLOW CONE NOZZLES

RA

IN LINE SPRAY/INSIDE VANE

RA nozzles work on the tangential jet principle and produce a very fine spray with a hollow cone spray pattern, in line with the inlet pipe. The carefully machined inside vane has two precision machined spiral grooves, which produce a wide range of capacities starting from very low values. When low capacity nozzles are used, because of the limited inner passages, it is recommended that the spray manifold should be fitted with a filter of the proper mesh size.

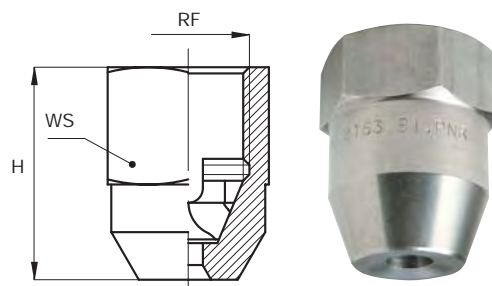

Materials B31 AISI 316 L Stainless steel
 T1 Brass

Code	RF inch	D mm	D1 mm	Capacity at different pressure values									Dimensions mm	
				0.5	0.7	1.0	2.0	3.0	5.0	7.0	10	H	WS	
80° RAT 0200 xx RAT 0390 xx	1/8	1.0	0.5	0.08	0.10	0.12	0.16	0.20	0.26	0.31	0.37	18	17	
		1.7	0.5	0.16	0.19	0.23	0.32	0.39	0.50	0.60	0.71			
60° RAQ 0490 xx RAQ 0770 xx RAQ 1122 xx	3/8	1.1	0.6	0.20	0.24	0.28	0.40	0.49	0.63	0.75	0.89	29	22	
		1.6	0.6	0.31	0.37	0.44	0.63	0.77	0.99	1.18	1.41			
		2.0	0.6	0.50	0.59	0.70	1.00	1.22	1.58	1.86	2.23			
90° RAU 1208 xx RAU 1306 xx RAU 1490 xx RAU 1612 xx RAU 1772 xx RAU 2104 xx RAU 1491 xx RAU 1551 xx RAU 1686 xx RAU 1980 xx RAU 2137 xx RAU 2153 xx RAU 2196 xx	3/8	3.0	1.0	0.85	1.00	1.20	1.70	2.08	2.69	3.18	3.80	29	22	
		4.0	1.6	1.25	1.48	1.77	2.50	3.06	3.95	4.67	5.59			
		4.2	1.6	2.00	2.37	2.83	4.00	4.90	6.33	7.48	8.95			
		4.7	1.6	2.50	2.96	3.53	5.00	6.12	7.90	9.35	11.2			
		5.5	1.6	3.15	3.73	4.46	6.30	7.72	10.0	11.8	14.1			
		6.3	1.6	4.25	5.02	6.00	8.49	10.4	13.4	15.9	19.0			
	1/2	5.0	1.8	2.00	2.37	2.83	4.00	4.90	6.33	7.48	8.95	36	27	
		5.5	1.8	2.25	2.66	3.18	4.49	5.50	7.10	8.40	10.0			
		6.0	1.8	2.80	3.31	3.96	5.60	6.86	8.86	10.5	12.5			
		6.3	2.0	4.00	4.73	5.66	8.00	9.80	12.7	15.0	17.9			
		6.7	2.0	5.59	6.62	7.91	11.2	13.7	17.7	20.9	25.0			
		7.5	2.0	6.45	7.63	9.12	12.9	15.8	20.4	24.1	28.8			
		9.0	2.0	8.00	9.47	11.3	16.0	19.6	25.3	29.9	35.8			

HOLLOW CONE NOZZLES

RB

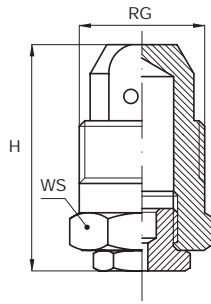

IN LINE SPRAY / VANELESS

These nozzles produce a hollow cone spray pattern, in line with the nozzle inlet pipe.

Their design, without any inside whirling vane, offers wide unobstructed passages and minimizes clogging danger while producing fine droplets.

The above characteristics make these nozzles the ideal solution for dust suppression applications, specially suited for coal dust control.

Materials B1 AISI 303 Stainless steel
 T1 Brass

Code	RG inch	D mm	D1 mm	Capacity at different pressure values									Dimensions mm	
				0.5	0.7	1.0	2.0	3.0	5.0	7.0	10	H	WS	
60°	3/8	2.0	2.0	0.65	0.77	0.93	1.31	1.60	2.07	2.44	2.92	31	17	
				0.94	1.11	1.33	1.88	2.30	2.97	3.51	4.20			
				1.59	1.88	2.25	3.18	3.90	5.03	5.96	7.12			
				2.57	3.04	3.64	5.14	6.30	8.13	9.62	11.5			
				3.18	3.77	4.50	6.37	7.80	10.1	11.9	14.2			
				4.49	5.31	6.35	8.98	11.0	14.2	16.8	20.1			
70°	1/2	3.3	3.2	1.59	1.88	2.25	3.18	3.90	5.03	5.96	7.12	37	22	
				2.57	3.04	3.64	5.14	6.30	8.13	9.62	11.5			
				3.18	3.77	4.50	6.37	7.80	10.1	11.9	14.2			
				4.82	5.70	6.81	9.63	11.8	15.2	18.0	21.5			
				6.45	7.63	9.12	12.9	15.8	20.4	24.1	28.8			
				7.96	9.42	11.3	15.9	19.5	25.2	29.8	35.6			
	3/4	3.3	3.3	3.3	1.59	1.88	2.25	3.18	3.90	5.03	5.96	7.12	43	32
					2.57	3.04	3.64	5.14	6.30	8.13	9.62	11.5		
					3.18	3.77	4.50	6.37	7.80	10.1	11.9	14.2		
					4.82	5.70	6.81	9.63	11.8	15.2	18.0	21.5		
					6.45	7.63	9.12	12.9	15.8	20.4	24.1	28.8		
					7.96	9.42	11.3	15.9	19.5	25.2	29.8	35.6		
					15.9	18.8	22.5	31.8	39.0	50.3	59.6	71.2		
					18.8	22.5	31.8	39.0	50.3	59.6	71.2	85.8		
80°	1+1/2	10.0	*7.9	12.7	15.0	17.9	25.3	31.0	40.0	47.4	56.6	69	50	
				*9.5	15.9	18.8	22.5	31.8	39.0	50.3	59.6			71.2
				*9.5	19.2	22.7	27.1	38.4	47.0	60.7	71.8			85.8
				*9.5	22.5	26.6	31.8	44.9	55.0	71.0	84.0			100
				*9.5	25.7	30.4	36.4	51.4	63.0	81.3	96.2			115
				*9.5	28.6	33.8	40.4	57.2	70.0	90.4	107			128
				*9.5	31.8	37.7	45.0	63.7	78.0	101	119			142
				*9.5	35.1	41.5	49.7	70.2	86.0	111	131			157
				*9.5	38.4	45.4	54.3	76.8	94.0	121	144			172

* Double inlet orifice

HOLLOW CONE NOZZLES

RC

IN LINE SPRAY

RC type nozzles produce a hollow cone spray pattern, in line with the nozzle inlet pipe.

The spray is produced by deflection of the water flow against a fixed plate in front of the nozzle orifice, which allows at the same time to obtain an high efficiency, small drop size and very wide spray angles.

Materials B1 AISI 303 Stainless steel
 T1 Brass

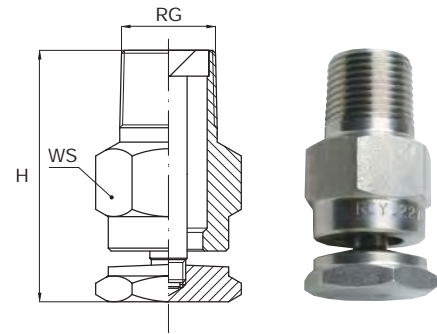

Spray Angle	1/4"	3/8"	Code	Capacity at different pressure values								Dimensions mm	
				0.5	0.7	1.0	2.0	3.0	5.0	7.0	10	H	WS
150°	•		RCY 1780 xx			4.50	6.37	7.80	10.1	11.9	14.2	33	17
			RCY 2117 xx	5.70	6.81	9.63	11.8	15.2	18.0	21.5			
			RCY 2157 xx	7.58	9.06	12.8	15.7	20.3	24.0	28.7			
			RCY 2196 xx	9.42	11.3	15.9	19.5	25.2	29.8	35.6			
	•	•	RCY 2230 xx	9.39	11.1	13.3	18.8	23.0	29.7	35.1	42.0	44	22
			RCY 2270 xx	11.0	13.0	15.6	22.0	27.0	34.9	41.2	49.3		
			RCY 2310 xx	12.7	15.0	17.9	25.3	31.0	40.0	47.4	56.6		
			RCY 2350 xx	14.3	16.9	20.2	28.6	35.0	45.2	53.5	63.9		
			RCY 2390 xx	15.9	18.8	22.5	31.8	39.0	50.3	59.6	71.2		
180°	•		RCZ 1780 xx			4.50	6.37	7.80	10.1	11.9	14.2	33	17
			RCZ 2117 xx	5.70	6.81	9.63	11.8	15.2	18.0	21.5			
			RCZ 2157 xx	7.58	9.06	12.8	15.7	20.3	24.0	28.7			
			RCZ 2196 xx	9.42	11.3	15.9	19.5	25.2	29.8	35.6			
	•	•	RCZ 2230 xx	9.39	11.1	13.3	18.8	23.0	29.7	35.1	42.0	44	22
			RCZ 2270 xx	11.0	13.0	15.6	22.0	27.0	34.9	41.2	49.3		
			RCZ 2310 xx	12.7	15.0	17.9	25.3	31.0	40.0	47.4	56.6		
			RCZ 2350 xx	14.3	16.9	20.2	28.6	35.0	45.2	53.5	63.9		
			RCZ 2390 xx	15.9	18.8	22.5	31.8	39.0	50.3	59.6	71.2		

Common applications

RC series hollow cone nozzles are used mainly for air washing, dust suppression and cooling processes.

The accessories shown below can be used for their protection against clogging, or for an appropriate assembly.

Please see our accessories Catalogue CTG AC20.

Assembly fittings



VEM



ZRP



ZPM

HOLLOW CONE NOZZLES

RX/RZ



RX

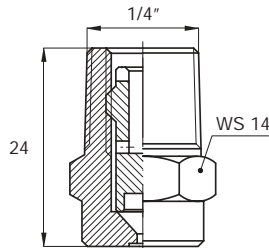

RZ

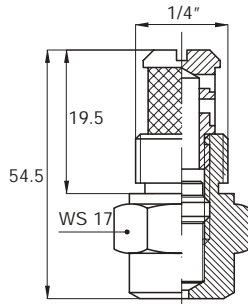

HYDRAULIC ATOMIZERS

Hydraulic atomizers are designed to deliver a very finely atomized hollow cone spray, even at low pressure values.

The nozzle contains a precisely machined insert with tiny passages, which can be disassembled for cleaning should the nozzle be clogged. Protection against clogging can be achieved either through a strainer on the main manifold, or by means of an optional individual filter VEF (see accessories catalogue CTG AC20).

We offer two types of bodies, RX with tapered thread and spray angle 80°, and RZ with straight thread and different spray angle values.

Materials	B1	AISI 303 Stainless steel	(RX)
	B3	AISI 316 Stainless steel	(RZ)
	T1	Brass	(RX)

Capacities shown in the above table are given in liters per hour.

Code	D mm	Capacity at different pressure values										(lph) (bar)
		1.5	2.0	3.0	4.0	5.0	6.0	10	15	20	50	
80°	RXT 0060 xx	0.50		2.94	3.60	4.16	4.65	5.09	6.57	8.05	9.30	14.7
	RXT 0100 xx	0.50		4.90	6.00	6.93	7.75	8.49	11.0	13.4	15.5	24.5
	RXT 0130 xx	0.70	5.52	6.37	7.80	9.01	10.1	11.0	14.2	17.4	20.1	31.8
	RXT 0190 xx	0.70	8.06	9.31	11.4	13.2	14.7	16.1	20.8	25.5	29.4	46.5
	RXT 0250 xx	1.00	10.6	12.2	15.0	17.3	19.4	21.2	27.4	33.5	38.7	61.2
	RXT 0380 xx	1.00	16.1	18.6	22.8	26.3	29.4	32.2	41.6	51.0	58.9	93.1
	RXT 0510 xx	1.50	21.6	25.0	30.6	35.3	39.5	43.3	55.9	68.4	79.0	125
	RXT 0650 xx	1.60	27.6	31.8	39.0	45.0	50.3	55.2	71.2	87.2	101	159
	RXT 0780 xx	1.90	33.1	38.2	46.8	54.0	60.4	66.2	85.4	105	121	191
	RXT 0910 xx	1.90	38.6	44.6	54.6	63.0	70.5	77.2	99.7	122	141	223
	RXT 1116 xx	1.90	49.2	56.8	69.6	80.4	89.9	98.4	127	156	180	284
	RXT 1143 xx	1.90	60.7	70.1	85.8	99.1	111	121	157	192	222	350
RXT 1166 xx	2.20	70.4	81.3	99.6	115	129	141	182	223	257	407	

Capacities shown in the above table are given in liters per minute.

Code	D mm	Capacity at different pressure values										(lpm) (bar)
		1.5	2.0	3.0	4.0	5.0	6.0	10	15	20	50	
60°	RZQ 0080 xx	0.45		0.07	0.08	0.09	0.10	0.11	0.15	0.18	0.21	0.33
	RZQ 0120 xx	0.55		0.10	0.12	0.14	0.15	0.17	0.22	0.27	0.31	0.49
	RZQ 0250 xx	0.80	0.18	0.20	0.25	0.29	0.32	0.35	0.46	0.56	0.65	1.02
	RZQ 0390 xx	1.00	0.28	0.32	0.39	0.45	0.50	0.55	0.71	0.87	1.01	1.59
	RZQ 0560 xx	1.20	0.40	0.46	0.56	0.65	0.72	0.79	1.02	1.25	1.45	2.29
	RZQ 0780 xx	1.40	0.55	0.64	0.78	0.90	1.01	1.10	1.42	1.74	2.01	3.18
	RZQ 1100 xx	1.60	0.71	0.82	1.00	1.15	1.29	1.41	1.83	2.24	2.58	4.08
	RZQ 1140 xx	1.90	0.99	1.14	1.40	1.62	1.81	1.98	2.56	3.13	3.61	5.72
	RZQ 1170 xx	2.10	1.20	1.39	1.70	1.96	2.19	2.40	3.10	3.80	4.39	6.94
	RZQ 1200 xx	2.30	1.41	1.63	2.00	2.31	2.58	2.83	3.65	4.47	5.16	8.16

Additional spray angles

RZ nozzles with orifice equal or larger than 1,0 mm can be produced with angles of 30°, 45°, 60° or 90°. The table beside shows the nozzle identifying codes for these spray angles.

Spray angle codes

RZF	RZM	RZQ	RZU
30°	45°	60°	90°



VEF

PNR PRODUCT RANGE

PNR manufactures, in addition to the range of general purpose nozzles shown in this Catalogue, a wide range of other products and systems allowing you to optimize the use of liquid spray and fluid control in most modern industrial processes. You will find our high quality, proven products shown in the following catalogs:

CTG AC20



Accessories Catalogue

A complete line of nipples, clamps, swivel joints and everything that helps you to easily assemble, align and service your spraying systems.

Air blowers, mixing eductors, filters, cleaning guns and lances, hose reels, steam heaters, pressure tanks, quick couplings to help build a professional system.

CTG SP10

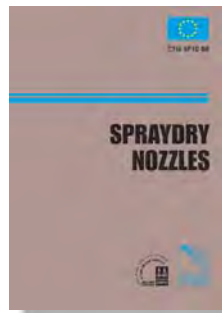

Spraydry nozzles

High pressure or air assisted precision nozzles manufactured with top quality stainless steel housings and tungsten carbide internals. A complete line of nozzles to retrofit existing plants at competitive prices. Only the highest quality materials and the most precise machining are employed in the manufacture of our nozzles, to assure precisely defined results and consistent wear life.

CTG LS20



Tank washing systems

Everything from the simple fixed sprayballs and pintle nozzles to the twin-axis washer heads. Reaction driven, water driven and electric or pneumatic motor driven. Professional inside surface cleaning of industrial tanks with the latest technology, together with state of the art accessories.

CTG PM10



Papermill products

A sixteen page Catalogue showing products specially developed for perfect results on paper making machines, including our patented disc nozzle for self-cleaning pipes, needle nozzles with sapphire and ruby orifice, oscillating pipes with high quality computer driven motor.

CTG AZ18



Air assisted atomizers

Ultrasonic, classic and automatic atomizers for the finest atomization in any process.

High quality machining and tight quality control assure a professional result to your system. Control cabinets and spray programmers allow for complete humidification systems to be easily assembled.

CTG SW20



Steelwork nozzles

A complete line of nozzles for steelwork applications, including continuous casting air atomizers and conventional nozzles, descaling nozzles for high pressure systems, fixed position dovetail tips and coke quenching high capacity flanged nozzles.

CTG LN16



Gas cooling lances

Spillback or air assisted lances for gas cooling processes in steelworks, cement plants and other industrial applications.

We can supply spare parts, retrofit your system or even supply a complete system, PLC driven, to upgrade tower performance to the latest technical standards.

CTG FF10



Fire fighting products

Everything for fixed and mobile foam systems, bladder tanks, any kind of foam mixer, monitors, foam lances and foam nozzles, mobile trailers for foam systems, pressure water nozzles and watermist nozzles, hydrants.

NOTE

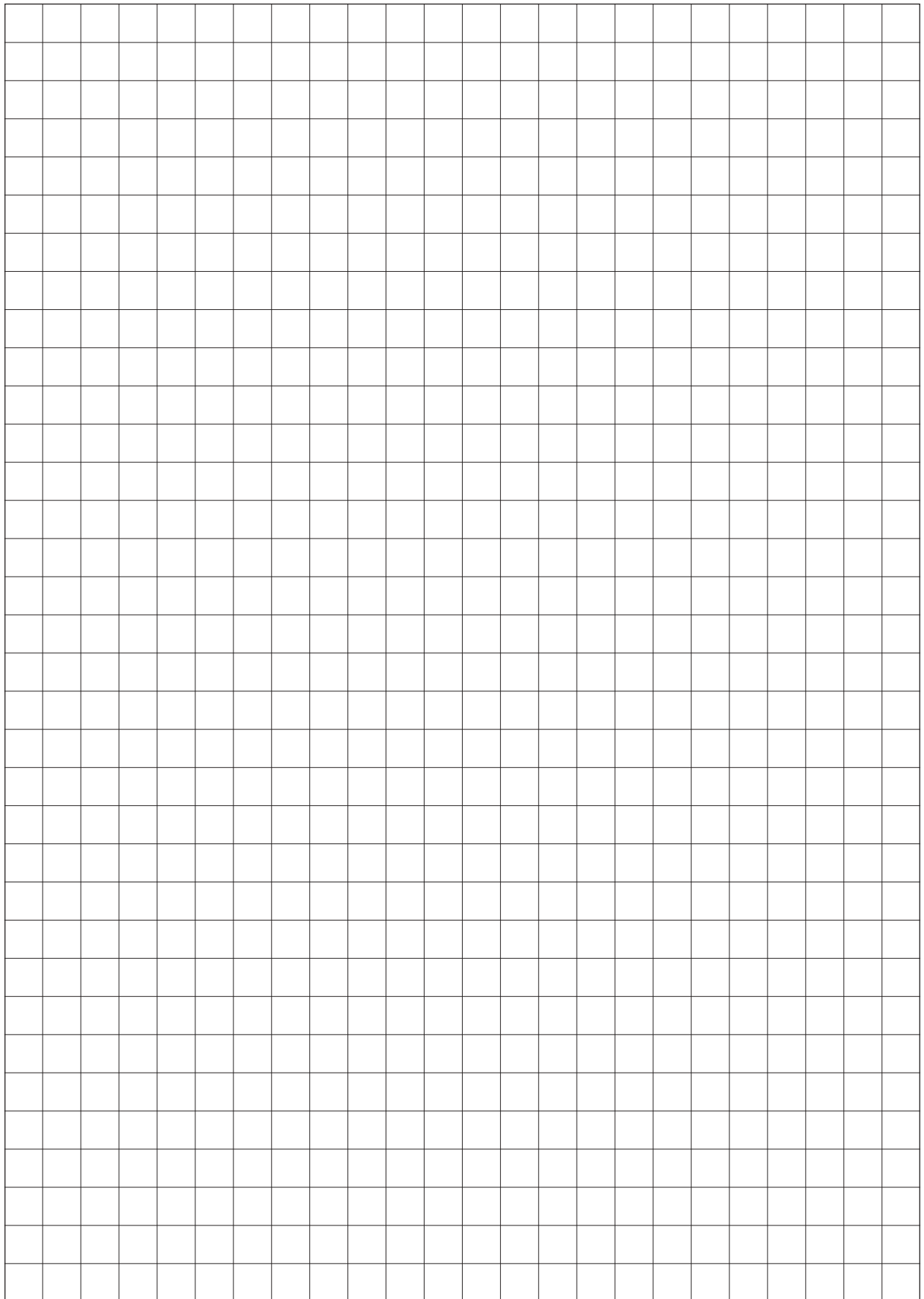

GENERAL INFORMATION

ABBREVIATIONS

CL	Jet deflection angle	deg	DU	Liquid outlet dia	mm	RF	Female BSP straight thread	inch
D	Conventional orifice dia	mm	FF	Flange outer dia	mm	RG	BSPT male taper thread	inch
D1	Smallest free inside dia	mm	G	Flange center-hole dia	mm	SQ	Square bar size	mm
DE	Liquid inlet dia	mm	H, H1	Height	mm	W	Weight	gram, kg
DF	Flange size	inch	L, L1	Length	mm	WS	Wrench size	mm
DIA	Outside diameter	mm	NR	Number of orifices	-			
DN	Flange nominal size	mm	QC	Quickfit connection	-			

PRODUCT WARRANTY

PNR products will be replaced or repaired at the option of PNR and free of charges if found defective in manufacturing, labelling or packaging. The above warranty conditions will apply if notice of defect is received by PNR within 30 days from date of product installations or one year from date of shipment. The cost of above said replacement or repair shall be the exclusive remedy for any breach of any warranty, and PNR shall not be held liable for any damage due to personal injuries or commercial losses coming from product malfunction.

Our Company Procedure for warranty cases requires the following steps to be performed:

- 1 Contact our Quality manager and obtain from PNR a return authorization number
- 2 Return the products together with our Form 3DA A04 duly completed
- 3 PNR shall issue a test report, send you a copy and return the product repaired or replaced.

Our Company scope is to offer full Customer satisfaction, and we are fully aware of the inconvenience which can be originated from a defective product. Please be assured we shall do our best to make available a perfect product in the shortest possible time.

PRODUCT RETURN POLICY

PRODUCTS DELIVERED IN ERROR FROM PNR

- 1 Obtain from PNR a return authorization number together with a Form 3DA A04
- 2 Return the products together with our Form 3DA A04 duly completed
- 3 PNR shall issue a Credit Note for full Product and shipping costs.

PRODUCTS ORDERED INCORRECTLY TO PNR

- 1 Obtain from PNR a return authorization number together with a Form 3DA A04
- 2 Return the products at your expense together with the form 3DA A04 duly completed
- 3 Products shall be returned in original condition, inside the original packaging
- 4 A re-stocking change of 10% applies.

NON CATALOG PRODUCTS

These products can only be returned after a written authorisation from PNR has been obtained.

DISCLAIMER

Our products are manufactured with the best care and according to the latest developments of the technology, but we cannot assure that every one of our products is perfectly fit for any possible specific process. The information in this Catalogue is provided "as is" and we make no warranty of any kind with respect to the subject matter or accuracy of the information contained herein. This publication may include technical inaccuracies or typographical errors and changes may be periodically made to the information herein without prior notice.

SENDING LIST

In order to automatically receive updates of our technical Documentation please photocopy this card and send it to us inside a sealed envelope, your details shall be kept on our Permanent Mailing List.

CTG UG20

01	COMPANY		PRODUCT RANGE		FIRE FIGHTING PRODUCTS	
02	NAME		GENERAL PURPOSE SPRAY NOZZLES		PAPERMILL PRODUCTS	
03	FUNCTION		AIR ASSISTED ATOMIZERS		STEELWORK NOZZLES	
04	ADRESS		COMPLEMENTARY PRODUCTS AND ASSEMBLY FITTINGS		SPRAYDRY NOZZLES	
05	PHONE	FAX	INDUSTRIAL TANK WASHING SYSTEMS			
06	WEB SITE	E-MAIL	EVAPORATIVE COOLING SYSTEMS			



磐亞噴霧系統(常州)有限公司
江蘇省常州太湖東路9-4號 常州創意產業園D棟921室 郵編213022
Tel : 0519-89661671 Fax : 0519-89661673
Website : www.pnr-china.com
E-mail : sales@pnr-china.com

CTG UG20 BR

www.pnr-china.com



Our products are distributed through:

PNR America
PNR Asia
PNR Baltic

PNR Benelux
PNR Czech Republic
PNR Deutschland
PNR China

PNR Italia
PNR Mexico
PNR U. Kingdom
PNR France

We are moreover represented in:

Argentina
Australia
Austria
Brazil
Bulgaria
Canada
Chile
China
Croatia
Denmark
Finland
Greece

India
Indonesia
Iran
Ireland
Korea
Malaysia
Norway
New Zealand
Pakistan
Philippines
Poland
Portugal

Rumenia
Russia
Serbia
Singapore
Slovenja
Spain
South Africa
Sweden
Taiwan
Turkey
Venezuela

