

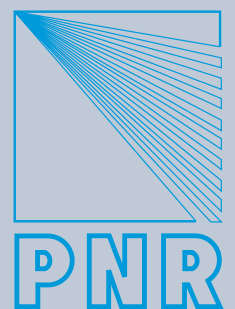

CTG LN16 BR

EVAPORATIVE COOLING



INTRODUCTION

INDEX

INTRODUCTION	Evaporative cooling _____	Page 1
	Spray characterization _____	3
	Application details _____	4
HYDRAULIC SPILLBACK LANCES	Operation principle _____	5
	Spill-back lance design _____	7
	Nozzle working diagrams _____	9
	Typical system lay-out _____	11
AIR ASSISTED LANCES	A new technology _____	12
	Single orifice nozzles _____	14
	Multi orifice nozzles _____	15
	Typical system _____	16
ADDITIONAL INFORMATION	Abbreviations, warranty conditions, sending list _____	17

TECHNICAL PUBLICATIONS

PNR manufactures a complete range of spray nozzles for industrial application, and several products and systems based on spray technology.

The following catalogues describe our complete product range:

PRODUCT RANGE	CTG TV 10 BR
GENERAL PURPOSE SPRAY NOZZLES	CTG UG 14 BR
AIR ASSISTED ATOMIZERS	CTG AZ 15 BR
COMPLEMENTARY PRODUCTS AND ASSEMBLY FITTINGS	CTG AC 15 BR
INDUSTRIAL TANK WASHING SYSTEMS	CTG LS 15 BR
EVAPORATIVE COOLING LANCES	CTG LN 16 BR
SPRAYDRY NOZZLES	CTG SP 10 BR
STEEL WORK NOZZLES	CTG SW 10 BR

Our technical publications are continuously updated, and mailed to Customers whose name and address are registered into our Catalogue Mailing List.

We shall gladly register your name, if you mail to the nearest PNR office the form on page 17, duly filled with the required information.

NOTES

Our products are continuously reconsidered and modified to keep up with the latest state of technology.

We regret not to be able to give our Customers previous advice about these modifications: for this reason the data and product specifications given in this catalogue are to be understood as indications, and do not engage our Company.

In case your application should imperatively require that one or more characteristics of one of our products is strictly maintained, we ask you to obtain a written confirmation about your requirements before sending your order.

All information contained into this catalogue, including product data, product codes, diagrams and photographs are the exclusive property of Flowtech Srl.

It is formally forbidden to reproduce any part of this catalogue without having obtained written permission of Flowtech Srl.

Dimensions in this catalogue are given in millimeter (mm).

All threads are manufactured according to the ISO 228 standards.

(European norms BS 2779 - DIN 259 - UNI 338).

Explanations about the abbreviations used in the catalogue are given at page 17.

All Trademarks are the property of their respective owners.

Please read our Warranty Conditions at page 17.

COMMON APPLICATIONS

Quenching of hot gases is a common operation in a number of industrial processes involving combustion of coal, oil or waste products as well as in a variety of chemical processes, cement manufacture etc.

The objective of gas quenching is primarily to cool a gas stream from a high temperature (eg 950° C) to a lower one so as to allow or enhance the collection of suspended particles in a downstream dust collector.

While a baghouse requires only gas cooling to allow the use of reasonably priced filter media, an electrostatic precipitator would require in addition the humidity value of the stream to keep dust resistivity in a certain range.

Additional process operations can be performed at the same time, like for example eliminate residual gases such as SO₃.

These results are achieved by atomization of water or aqueous suspensions into the gas stream, so that the evaporation of water droplets can remove the excess heat and control the humidity value of the gas stream.

The process consists into injection of a cooling liquid at ambient temperature into the hot gas stream flowing through the cooling tower, where the liquid is first taken to its boiling temperature, then evaporated into steam, subsequently superheated up to the hot gas stream temperature.

HEAT TRANSFER

To achieve satisfactory performance of an evaporative cooling process the following conditions must be met:

A

A sufficient quantity of cooling liquid must be atomized and evaporated, to take away from the gas stream the desired quantity of heat.

Such parameters as the specific heat of the smoke mix (air, gases and solid content) and latent evaporation heat of the cooling fluid must be taken into account .

B

The cooling liquid shall be finely atomized, into droplets with a well-defined size spectrum.

Both the droplet mean diameter and the largest drop diameter are important process parameters for the design of the quenching tower.

The nozzles designed to be used with cooling lances produce the best possible atomization, each design being tested with sophisticated equipment to match stringent requirements.

C

The spray system must be so designed that the changes in the hot gas stream flow rates, which are originated by the different operation conditions of the furnace, can be safely met by means of an adequate turn down ratio in the water spray capacity.

D

The spray orientation and the spray pattern inside the quenching tower must be designed so as to avoid wetting of the refractory lining on the inside walls of the tower.

EVAPORATIVE COOLING

COOLING PROCESSES

Atomizing a given mass of liquid into fine droplets increases its surface considerably, as an example atomizing one kg of water into droplets with a small diameter can develop a total surface of several hundred square meters.

Since the evaporation of atomized droplets depends upon the difference in temperature between liquid and gas, and upon the value of exchange surface, it is then clear that fine atomization can allow very short evaporation times.

This makes it possible, all others conditions unchanged, to have shorter quenching towers.

Gas quenching processes are rather complicated to be precisely calculated because of a number of factors.

For example the specific heat value of the gas stream should be calculated taking into account those of the different gases in the mix and of the suspended solid particles.

In the preliminary design step, the following simplifications can be assumed to determine basic design parameters

A

Gas speed and temperature along the tower are considered to remain constant

B

Collisions and consequent coalescence between droplets are ignored

C

Cooling liquid characteristics are retained constant along the process

GENERAL DESIGN CONDITIONS

The purpose of these processes is bringing the highest possible number of fine droplets, within the shortest possible time after the leaving the nozzle orifice, in contact with the hot gas stream and this with the most uniform distribution within the steam.

To optimize the system design lances with different nozzles positions are available.

When designing a gas conditioning tower the following design conditions should be met.

1- Even gas velocity distribution

This is obtained by an accurate design of the tower interior profile, including position and orientation of baffles, so that the gas stream is led to flow with the highest uniformity of flux.

Cooling lances should always be positioned in a stable flow area of the tower.

2 - Even water spray

The lances should be positioned in such a pattern that the spray does not foul onto the inside wall or baffleplates.

Apart to reduce the cooling efficiency of the system (part of the water is not evaporated into the gas stream) this can lead to several inconveniences like wet tower bottom, corrosion on tower wall, and refractory damages.

3 - Uniform cooling effect

An accurate lances layout is of utmost importance to achieve the best possible system efficiency.

The lances should be positioned in such a way that their sprays cover the widest possible area in the tower cross section, but care should be taken to avoid direct jet impact over the refractory on the inside tower wall.

4 - Tower dimensions

The tower height is directly dependent upon the droplet spectrum of the water spray, and should be so designed that complete evaporation is reached well before the outlet zone.

The evaporation path length, or the residence time of the droplet inside the tower, of a given water spray can be predicted, based on the gas stream velocity and the gas temperature.

The tower diameter has, obviously, a capital influence on such an important process parameter as the gas velocity.

SPRAY CHARACTERIZATION

Many industrial processes require the availability of finely atomized droplets and the techniques to produce atomized jets have been largely improved in the recent years, with new types of atomizers being developed.

In addition, more sophisticated process techniques have heightened the demand for a precise definition about the characteristics of the spray, with the most interesting parameters are listed below, and are now available to the design engineer.

Arithmetic Mean Diameter D10	AMD	This is the arithmetic mean value as calculated from the diameter of total number of sample droplets.
Volume Mean Diameter D30	VMD	This is the diameter of that droplet whose volume is the arithmetic mean among the volumes of all the droplets.
Sauter Mean Diameter D32	SMD	This is the diameter of the droplet whose Volume/Surface ratio is identical to the Volume/Surface ratio calculated over all the sample droplets.

In addition the following histograms and diagrams are usually used to define a spray:

- Volume Percentage Cumulative Curve
- Distribution curve of droplet diameters
- Distribution curve of droplet velocities

Above parameters and information make it possible to base process calculations upon precise data about atomizing degrees, process efficiency, and jet behavior in operational ambience.

The knowledge of the Sauter Mean Diameter (D32) is of special importance in heat exchange calculations about evaporative gas cooling processes, since it gives the possibility of evaluating the exchange surface obtained by atomizing for a given liquid volume.

PNR can supply upon request complete documentation containing test reports about all the aforementioned parameters and additional information, for all PNR atomizers. The diagrams beside show the distribution of the droplet diameters and the droplet velocities of a spray under test, as available to our customers. This documentation is also delivered, on request, for all PNR atomizers.

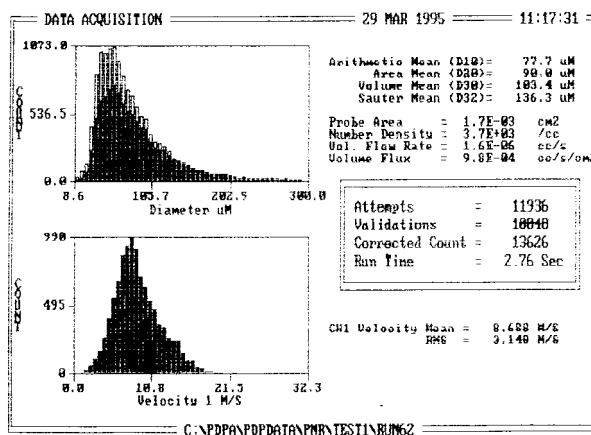

In the photograph beside a test being performed in our laboratories. Droplet sizes and other jet characteristics are being recorded by means of a laser interferometer, while flow rates and pressure are monitored through high precision instruments.



INTRODUCTION

APPLICATIONS DETAILS

As a courtesy to our customer we can suggest the water capacity needed to realize a cooling process under the given conditions of their project.

This service is rendered at no cost and without any process performance commitment from the side of PNR, and serves both the purpose of determining the number of lances needed for their application, and as a confirmation of our customer's calculations.

Please note the following information to be completed in order to enable our Engineering Department to follow your request.

Company Mail Address
Officer in charge Tel Fax

Process data

Gas flow rate under normal conditions	Ncmh
Gas flow rate under minimum/maximum design conditions	Ncmh
Gas wet percentage	
Inlet temperature of gas	...°C
Required outlet temperature	...°C
Gas speed inside tower	meters per second
Gas density	kg per cubic meter
Gas specific heat	kJ per kg per °K
Gas pressure	KPa
Gas composition	%

Tower data

Gas flow direction	-
Evaporation path length	m
Tower inside diameter	m

A drawing / sketch of the tower inside profile, including gas inlet duct and baffle plates, is required to determine the tower zone where the gas flow is under stationary conditions and to properly design the most suitable lance layout.

A software program for calculating the precise value of the specific heat of a given gas mix, which takes in account the different gases with their own specific heat, is available for our customers.

Please contact our Engineering department.

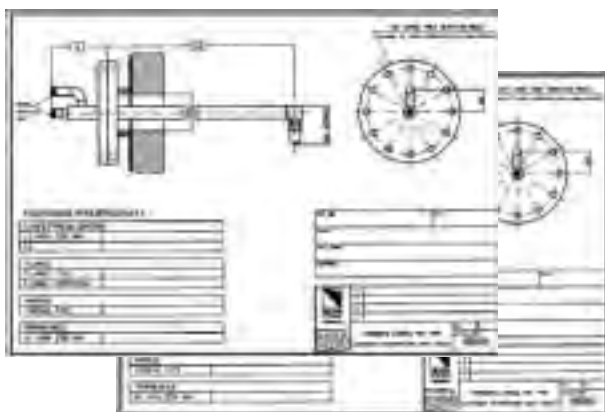

LANCE DIMENSIONS

In order to avoid mistakes and misunderstandings our customers are requested to confirm the appropriate information about required lance construction by filling our 9E forms.

These forms contains informations about lance connection flange and additional lance dimension, and serve the purpose of completely define the technical details about each order. One copy is included into our order confirmation to the customer, and is considered to be an integral part of the order itself.

Such forms are included in our files, to make sure the correct dimensions are always considered, should spare parts be necessary later on.

HYDRAULIC SPILLBACK LANCES

Spillback lances have gained a proven record of efficiency and reliability through long years of satisfactory service, and are widely used in a number of industrial processes like cement manufacturing, refuse incineration and cooling blast furnace gas in iron mills.

A spillback lance works on the principle of pressure atomization, with the liquid being atomized as the only fluid going through the nozzle.

Spillback lances can produce fine sprays over a wide capacity range with little changes in other spray characteristics, like droplet sizes, by means of an infinitely variable capacity adjustment with a 1:10 ratio.

The spray pattern is a hollow cone, with a typical spray angle of 90°.

To obtain the wide range of capacity values the spillback nozzle is provided with a return line, whereby a part of the liquid sent by the pump to the lance can bypass the nozzle and go back to the liquid tank without being atomized through the nozzle orifice. When the spillback line is closed, and no liquid can bypass, maximum nozzle capacity is available.

With the spillback line open, adjusting the flow through the line by means of a valve, one will determine the pressure value inside the nozzle whirl chamber and therefore the quantity of liquid being atomized.

Spillback lances can therefore offer a flexible response to changes in the requirements of the cooling process.

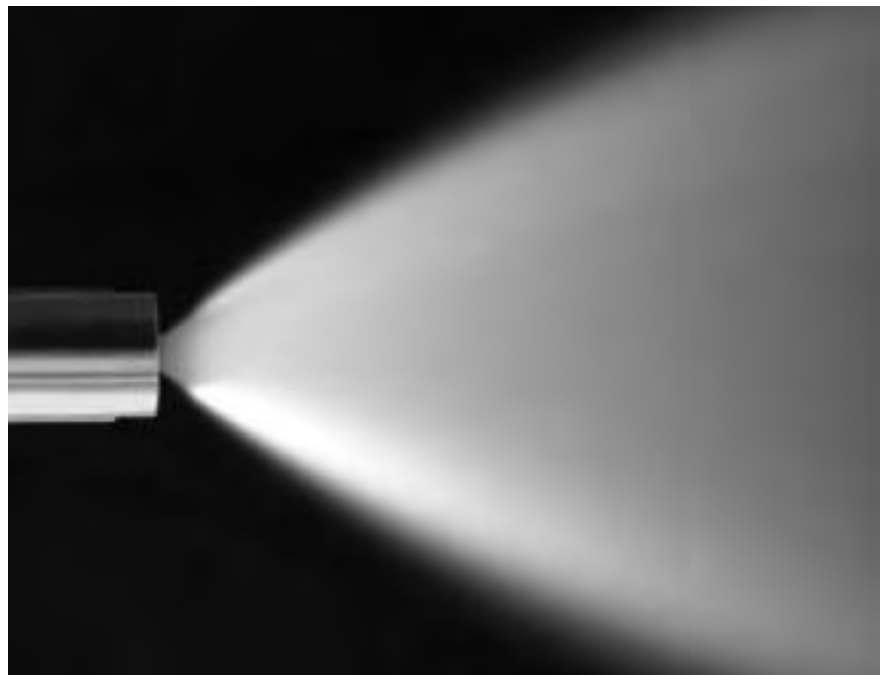

Operation principle	page 6
Working diagram	6
Spill back lance design	7
Spill back coding system	7
Composition of a spillback nozzle	8
Nozzle working diagrams	9
Spare parts	10
Typical system	11

OPERATION PRINCIPLE

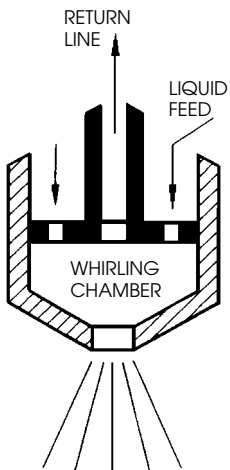

**WATER PATH INSIDE
A SPILLBACK NOZZLE**

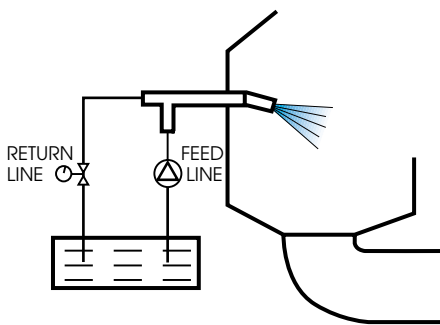

SYSTEM LAY-OUT

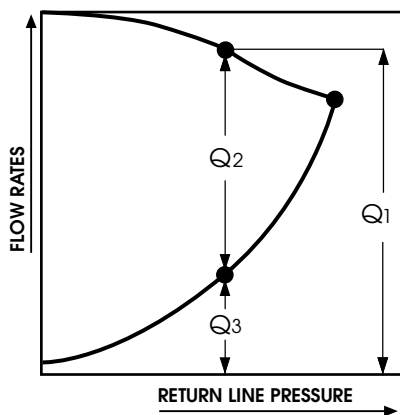

WORKING DIAGRAM

A graph similar to the one shown beside is available for each spill-back nozzle. It gives several curves, each one for a given pressure in the pump feed line. For each curve, the total pumped volume, the spray flow value and the return flow can be read for a given pressure in the return line. Along the regulation range, i.e. the pressure values in the return line to be read on the abscissa axis, the following relation is valid:

$$Q1 = Q2 + Q3$$

where $Q1$ = total flow pumped to the nozzle
 $Q2$ = returned flow
 $Q3$ = atomized flow

When the regulation valve is closed there is no spillback flow. Under this condition, at the nose of the curve, all the pumped flow is atomized, and therefore:

$$Q3_{max} = Q1 \quad (Q2 = 0)$$

Standard types of nozzles are shown in the following pages, their working diagrams can be found at page 9.

SPILL-BACK LANCES DESIGN

Spill-back lances are usually supplied as complete assemblies, including the nozzle, lance body, assembly flanges, connection hoses, double valve for feed and return line, and feed line filter.

Depending upon the flow value required, each lance can be equipped with one, three or six of the standard nozzle making available to the system designer a very wide choice.

Moreover, it is possible to manufacture lances out of special materials and super-alloys, as well as lances with special options like for example an outer protection pipe for air cooling.

The scheme on the right side, shows the different fittings usually supplied together with the actual lance:

- 1 - Double on / off valve
- 2 - Feed line filter
- 3 - Flexible hoses for feed and return lines
- 4 - One way valve on return line
- 5 - Quick-coupling connections for hoses.

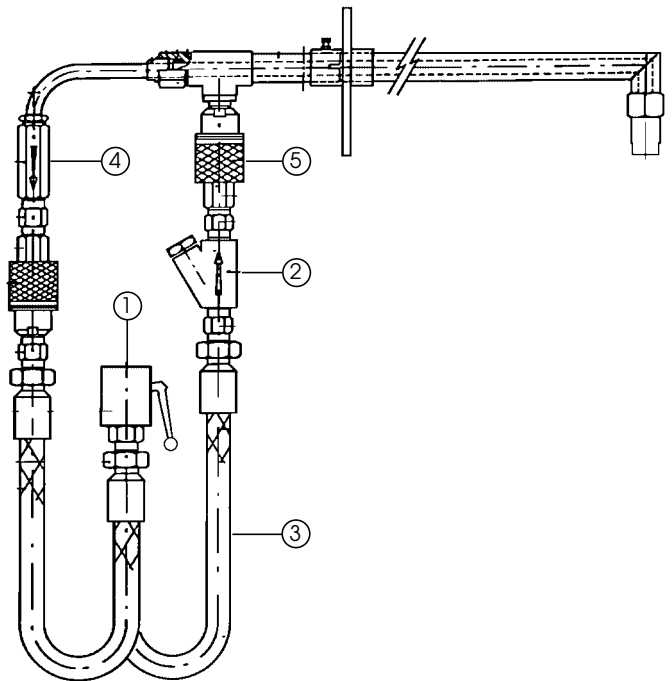

Manufacturing materials for standard lances as follows:

Lance pipes and nozzles	AISI 316 Stainless steel
Assembly flange	AISI 316 Stainless steel
Hose couplings and double valve	Zinc coated steel
Feed line filter	Carbon steel

Our spillback lances are identified by proper codes, which include the main lance specifications.

Our coding does not provide however some other informations which are typical for every specific intallation.

Such information is to be detailed on our specific 9E forms, which shall be supplied on request for each single quotation.

Once approved by customer, these forms become an integral part of the purchase order.

UGA BCDE GHJ

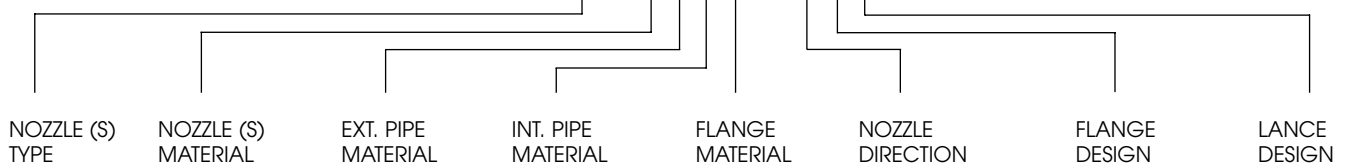

VALUES FOR CODING PARAMETERS

<p>A Nozzle type</p> <p>A ARU 1011 B ARU 1012 C ARU 1013 D ARU 1015 E ARU 1017 F ARU 1019</p> <p>B Nozzle material</p> <p>A AISI 316 SS B AISI 420 HSS C Titanium D Tungsten carbide E Other</p>	<p>C External pipe material</p> <p>See nozzle material codes</p> <p>D Internal pipe material</p> <p>See nozzle material codes</p> <p>E Flange material</p> <p>See nozzle material codes</p> <p>G Nozzle direction</p> <p>L Nozzle in line M Nozzle 45° up N Nozzle 90° up Y Nozzle 45° down Z Nozzle 90° down X Other</p>	<p>H Flange design</p> <p>Connection flange design according to:</p> <p>A ASA 10" 150# B 2550 NB flange BS4504 PN16 C Rectangular PNR standard D DIN DN 250 PN 16 X Other</p> <p>J Lance design</p> <p>Adjustable simple lances</p> <p>A Nominal length 500 mm B Nominal length 1000 mm C Nominal length 1500 mm</p>	<p>M Nominal length 500 + protection N Nominal length 1000 + protection P Nominal length 1500 + protection X Other</p>
--	---	--	--

COMPOSITION OF A SPILL-BACK NOZZLE

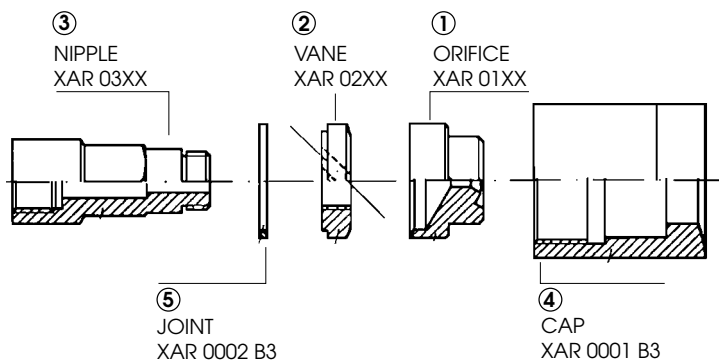
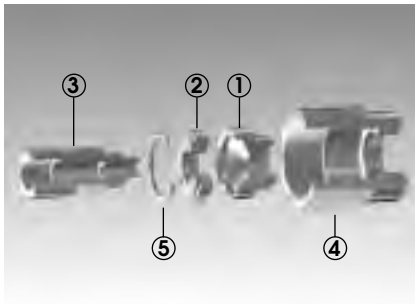

The spill-back nozzle, whose working principle has been explained at page 6, is actually made out of three pieces:

1. The actual nozzle orifice to spray atomized water into the cooling tower.
2. A vane which leads the water into the whirling chamber and gives it a rotary movement
3. A nipple which provides the passage to the return line

These three elements are kept together and fixed to the lance body by means of a locking cap (4).

The cap XAR 0001 B3 and the joint XAR 0002 B3 are identical for all types, while nipple, vane and orifice have a different design for each single nozzle size. The table on the side gives, for all sizes, the identification codes for complete nozzles and for single components as well as the flow value in liters per minute.

The given flow value is to be understood as the maximum flow at the pressure of 35 Bars, that is with the return line closed.

All nozzle components are normally manufactured out of AISI 316 grade Stainless steel. In case of rather high feed pressure, nozzle components can be subject to high wear, that causes a relatively rapid decadence of the performances of the nozzle. In these cases the nozzle orifice can be delivered in materials with higher wear resistance.

	Nozzle Set-up	Orifice	Vane	Nipple	Flow rate (lpm)
90°	ARU 1011 xx	XAR 0101 xx	XAR 0211 B3	XAR 0311 B3	5.30
	ARU 1012 xx	XAR 0102 xx	XAR 0212 B3	XAR 0312 B3	8.40
	ARU 1013 xx	XAR 0103 xx	XAR 0213 B3	XAR 0313 B3	10.5
	ARU 1015 xx	XAR 0105 xx	XAR 0215 B3	XAR 0315 B3	13.0
	ARU 1017 xx	XAR 0107 xx	XAR 0217 B3	XAR 0317 B3	16.5
	ARU 1019 xx	XAR 0109 xx	XAR 0219 B3	XAR 0319 B3	21.0

The available options are listed below, together with the respective PNR material codes.

Orifice Materials

- AISI 316 Stainless steel
- AISI 420 Hardened stainless steel
- Titanium
- Tungsten carbide

PNR codes

- B3
- C1
- H1
- F1

NOZZLE WORKING DIAGRAM

OPERATION DIAGRAMS

Capacity diagrams for our lower flow spillback nozzles are shown in this page. In addition our new range of nozzles covers the highest capacities up to 150 lpm at 20 bar. See page 6 for explanations about how to read a diagram. Droplet size information about a single nozzle and a given operating condition can be obtained on request.

Note

Three curves relating to the feed pressure values of 20, 35 and 50 bars are given for each nozzle.

Abscissas axes

Show the value of the spillback line pressure (Bar).

Ordinate axes

Show the flow rate values for pumped flow, spillback flow and atomized flow (Lpm).

Note

The flow rates values refer to water at 15°C (59°F).

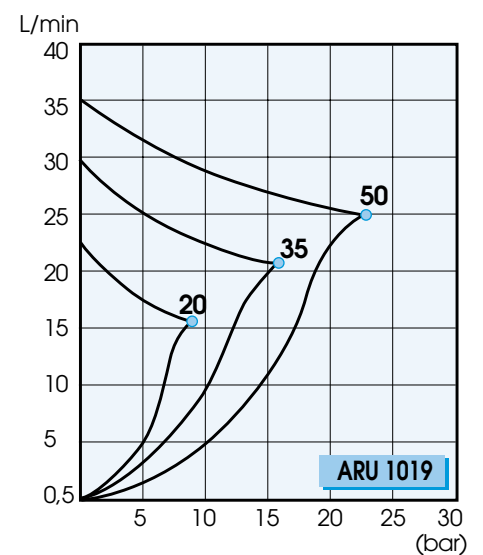
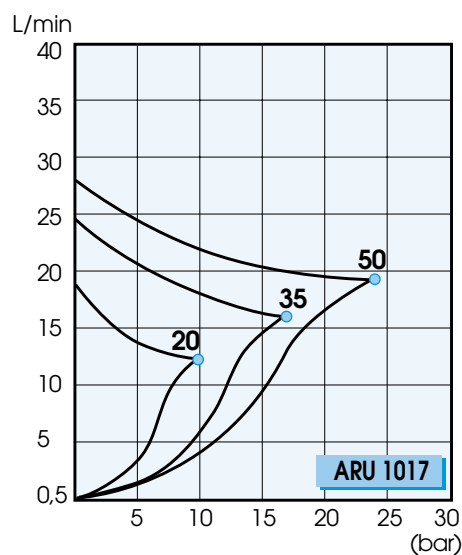
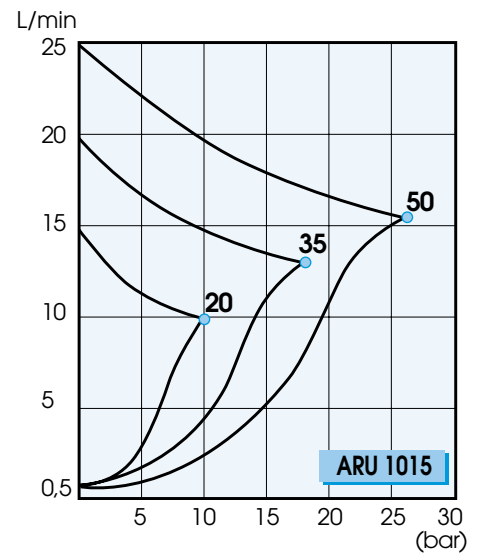
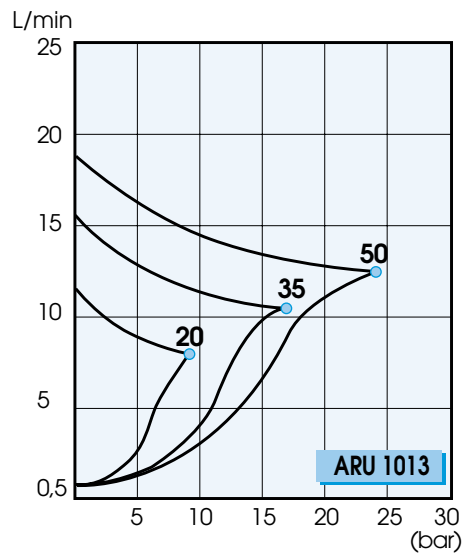
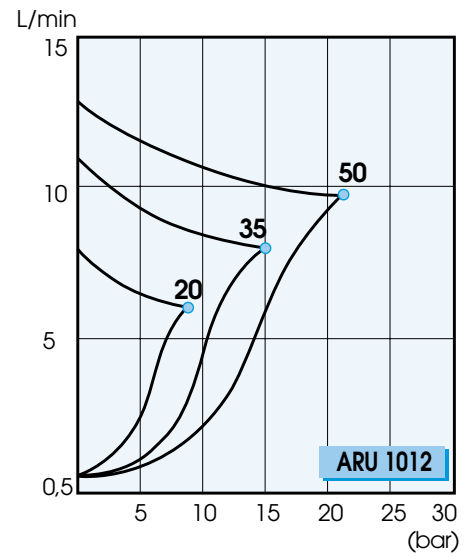
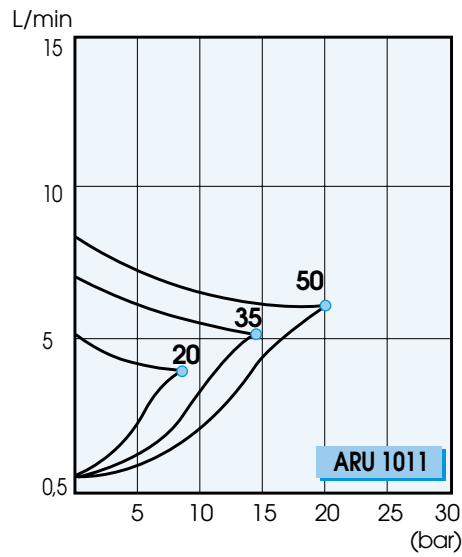

Note: capacity diagrams for higher flow range are available on request.

HYDRAULIC SPILL-BACK LANCES

SPARE PARTS

In this page all the components of a single-nozzle spill-back lance are listed, other than the nozzle, which are necessary for connecting the lance to the feeding and return main manifolds.

Components shown here suit a single-nozzle lance, while multiple nozzle lances require different parts.

NON RETURN VALVE XUG 0460 A8



Connection threads: 1/2" BSP Female
Max operating pressure: 320 Bars
Material: Carbon steel
zinc coated

COMPLETE QUICK COUPLING XUG A420 A8

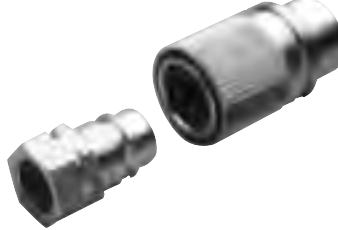

Connection threads: 1/2" BSP Female
Max operating pressure: 400 Bars
Material: Zinc coated steel

DOUBLE VALVE XUG 0430 A2

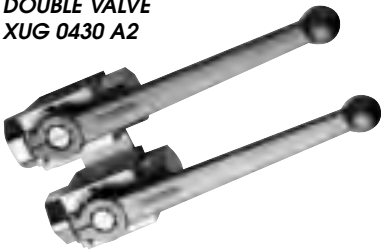

Connection threads: 1/2" BSP Female
Max operating pressure: 75 Bars
Temperature: -70C / 120C
Material: Carbon steel

LINE FILTER XUG 0400 B3



Connection threads: 1/2" BSP Female
Max operating pressure: 160 Bars
Cartridge wire: 100 mesh
Materials:
Body: AISI 316 Stainless steel
Filter cartridge: AISI 304 Stainless steel

OTHER COMPONENTS

FLEXIBLE HOSE XUG 0450 A8

Connection threads: 1/2" BSP Female
M 22 X 1.5
Max operating pressure: 110 bars
Temperature: -70/120 °C
Total length: 1000 mm
Inner material hoses: PTFE
Hose cover: Stainless steel wire
Nipples: Zinc coated steel

CONNECTION NIPPLES XUG AC01

Connection threads: 1/2" BSPT Male
M 22 X 1.5
Material: AISI 316 Stainless steel

XUG AC02

Connection threads: 1/2" BSPT Male
Material: AISI 316 Stainless steel

NOTE

All above components, on request, can be supplied made completely out of Stainless steel.

TYPICAL SYSTEM LAY-OUT

- 01 - High pressure pumps
- 02 - Filter assembly
- 03 - Regulation valve
- 04 - Electro-valve
- 05 - Pressure switch
- 06 - Safety valve
- 07 - One way valve
- 08 - Flowmeter
- 09 - Manometer
- 10 - Differential Manometer
- 11 - Double valve
- 12 - Thermocouple on inlet gas
- 13 - Thermocouple on outlet gas
- 14 - Spill-back lance
- 15 - PLC Temperature control

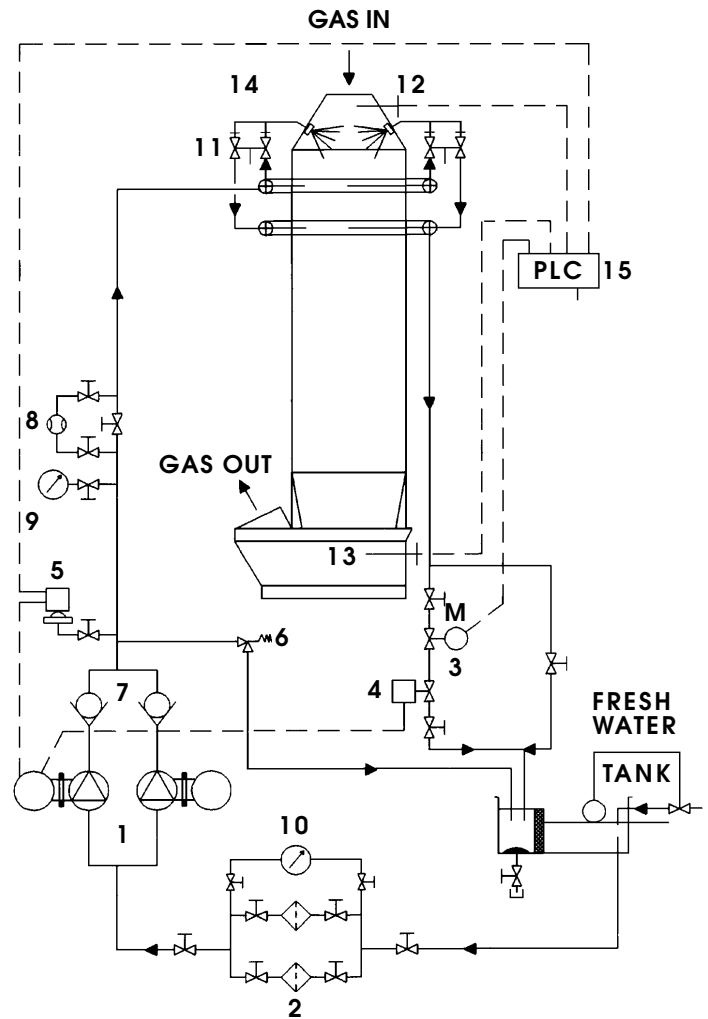

CHOOSING HIGH PRESSURE PUMPS

When designing a spillback lance system, some consideration must be given to the choice of pumps with the right specification. Because of the spillback working principle, and to keep the system stable in the different operation conditions, the pump characteristic diagram should be as flat as possible along the entire flow rate regulation range.

CAPACITY CALCULATION

$$Q_p = K \cdot n \cdot (Q_{3MIN} + Q_{2MAX})$$

- K = safety coefficient 1,20
- n = number of orifices
- Q3MIN = minimum atomized capacity (regulation valve totally open)
- Q2MAX = maximum spillback capacity (regulation valve totally open)

It must be noted that the required pump capacity is bigger than the maximum atomized flow rate, the highest capacity requirement being encountered when the system is working at the lowest atomization flow rate condition. The pump head must be choose allowing for friction head losses in the piping and for static head due to the tower height.

AIR ASSISTED LANCES

Air assisted atomizing lances use the most modern technology to produce the finest atomization available.

The energy of the compressed air jet is used to break and accelerate the water flow in a several stages process so as to obtain a high speed spray of very finely atomized drops.

The higher operating cost of this technology is then counterbalanced by some noticeable advantages.

1-Unrivalled efficiency

Which in turn allows for smaller tower dimensions and perfect evaporation of the cooling liquid.

Problems like wet tower bottom, sludge buildup, water pollution, drops carryover and refractory spalling are totally eliminated or greatly reduced.

2 - Very wide adjustment ratio

An additional advantage of this technology, where regulation of capacities can be performed over liquid flow ranges wider than those allowed from spillback nozzles.

This allows for precise temperature control in almost all possible conditions.

3 - High cooling capacities

Air assisted lances have inherently an higher capacity than spillback lances, and can easily be scaled up in dimensions. In addition smaller droplets have shorter evaporation times. Standard catalogue types offer capacities up to 150 lpm for water.

LONGER LIFE

The specific design of air assisted atomizing lances offers large orifices and inside passages together while their working principles only requires low fluid pressures and velocities.

These peculiar conditions allow not only for lower erosion on inside profile surfaces, which means longer nozzle life, but also for reduced risk of clogging.



Operation principle _____ page 13

Single orifice nozzles _____ 14

Multiple orifice nozzles _____ 15

Typical system _____ 16

OPERATION PRINCIPLE

The technique of using compressed air to obtain fine atomization is not new and has been applied since a long time to produce small capacity atomizers. Since a few years, however, this technology has undergone deeper investigation and the process of atomizing a two-phase mix (gas-liquid) can now be controlled with greater precision.

For air assisted lances are a very modern and efficient development in the field of evaporative cooling in general, and specifically for Gas Conditioning Towers (GCT). The energy of compressed air can be used to produce fine and very fine sprays, using the properties of the two-phase mix of air and water.

The following advantages are easily obtained in comparison to the conventional spillback pressure atomization.

- 1 - Much finer atomization, with easily reached values of 50 microns for SMD (D32).
- 2 - Lower fluid speed inside the nozzle, lower wear.
- 3 - Wider internal passages, less clogging danger.

WORKING DIAGRAMS

The performance of air assisted lances can be described either with tables or diagrams. In this catalogue tables are given, as the most concise mean of determining the first specification for a given system, in terms of number of lances and total flow values for air and water required.

For precise calculation of the system, and to make system regulation easier, we also supply operation diagrams where capacities for air and water feed pressure are plotted against the requested water flow rate. Air assisted lances require careful adjustment since, changing only one of the two fluid pressures, both flow rates vary at the same time.

For the above reason it is customary to adjust the lance keeping a given value for air pressure, and changing the water pressure values. Each one of our diagrams show therefore capacity curve for air and water pressure as a function of water flow rate, for a given air pressure value.

Our diagrams have been carefully conceived in order to furnish our customer with the most complete information in the most clear way, as shown by the diagrams this page.

HOW TO READ AN AIR ASSISTED LANCE DIAGRAM

- 1 - Note the air pressure value on the top of the page. This diagram describes the lance operation for that precise air pressure value.
- 2 - Find the point A, on the horizontal axe where your desired water flow rate value is given.
- 3 - Draw a vertical line downwards until the water pressure curve is met, and find point B, you can read on the left axis the water pressure value required.
- 4 - Draw a vertical line upwards until the air capacity curve is met, and find point C. You can now read on the vertical axis at your left the air flow capacity required under your given operating condition.

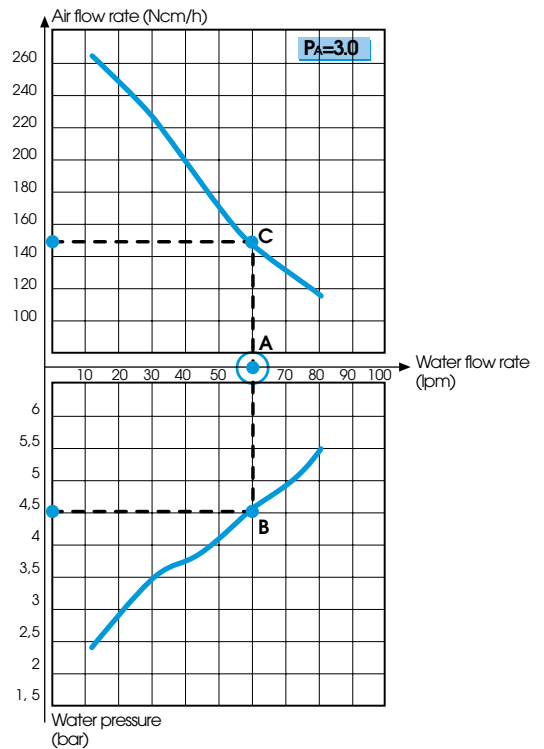

AIR ASSISTED LANCES

SINGLE ORIFICE NOZZLES

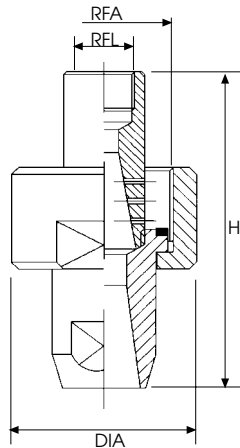

The air assisted lances of the NEB series work on the twin-fluid supersonic principle and provide a fine droplet spectrum. Air and liquid are mixed in the whirling chamber inside. The nozzle accelerates the mixture to supersonic velocity. These lances produces droplets with the following characteristics:

- Optimum particle distribution.
- Fine atomization.
- High exit velocity with an optimum particle exchange.

Materials

AISI 316 Stainless steel
Hastelloy C4

15°	Code	D1	D	Liquid pressure (bar)									Dimensions							
				2,0			3,0			4,0			RFA	RFL	H	SW				
				LC	AC		LC	AC		LC	AC									
15°	NEB 1490 B3	3,0	4,2	1,8	0,6	37	2,7	0,8	48	3,6	0,9	62	1 1/4"	3/8"	83	50				
				1,9	1,5	33	2,9	3,0	33	3,9	4,0	40								
				2,0	3,5	22	3,0	4,6	28	4,0	6,3	34								
	NEB 1740 B3	3,7	5,0	1,8	0,7	50	2,7	0,9	66	3,6	1,0	80								
				1,9	3,0	40	2,9	4,0	55	3,9	8,0	60								
				2,0	5,5	31	3,0	6,4	44	4,0	9,2	59								
	NEB 740 B3	2,0	5,5	1,5	1,0	58	2,2	1,2	76	3,2	1,2	95								
				1,8	5,0	52	2,6	7,0	69	3,6	10	83								
				2,0	10	48	3,0	14	60	4,0	19	73								
	NEB 2190 B3	2,8	7,6	1,5	1,2	95	2,2	1,5	124	3,1	1,8	155								
				1,7	7,0	90	2,5	10	112	3,5	15	140								
				2,0	18	71	3,0	19	100	4,0	23	136								
	NEB 2260 B3	3,2	9,5	1,4	1,2	155	2,2	1,5	200	3,0	1,8	250					1 1/2"	1/2"	112	55
				1,7	10	130	2,6	15	170	3,5	20	200								
				2,0	25	102	3,0	26	145	4,0	32	187								

CODING FOR AIR ASSISTED LANCE

Assigning a code containing detailed product description is of utmost importance for customer service along the life time operation of the product.

Apart from some information typical for every specific installation, which are defined within the already mentioned 9E type form, our air assisted lances are coded according to the following scheme.

Where the code parameters carry the following meanings

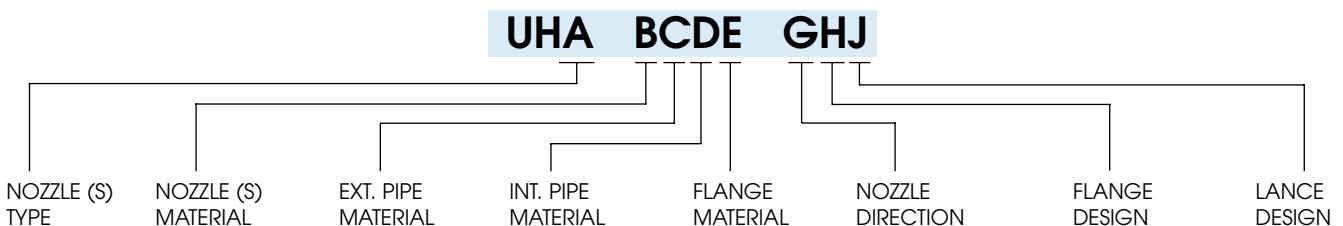

MULTI ORIFICE NOZZLES

The multi orifice nozzles of the NE series give the additional advantages of a wide operating liquid flow range, wider spray angles, assuring very fine spray characteristics. The typical design of these lances allows for the liquid feed nozzle to be easily replaced, and made out of wear resistant materials for those applications where solid particles suspended in the liquid would cause excessive erosion.

Materials

- Aisi 316 Stainless steel
- Hastelloy C276
- Hastelloy C22
- Hastelloy C4

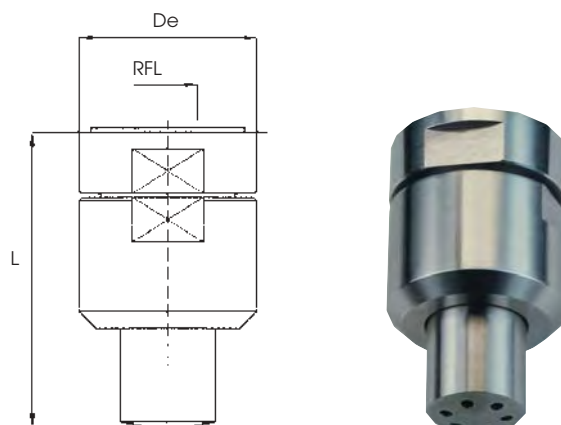

Code	Liquid pressure (bar)									Dimensions						
	3			4			5			L	De	RFL				
Code	LC	AC	LC	AC	LC	AC	LC	AC	LC	AC	L	De	RFL			
20°	NFC 2120	2,2	2	55	2,9	2	68	3,8	2	94	80	48,3	3/4"			
		2,8	6	40	3,6	6	52	4,4	6	75						
		3,3	9	30	4,2	9	42	5,3	9	62						
	NFC 2275	2,5	7	145	3,2	7	190	4,2	7	250				113	68,0	3/4"
		3,5	17	115	4,2	17	160	5,3	17	200						
		4,6	27	100	5,5	27	135	6,4	27	180						
	NFC 2340	2,6	15	150	3,2	15	185	4,2	15	230				113	68,0	3/4"
		3,3	34	100	4,2	34	125	5,2	34	170						
		4,3	50	70	5,2	50	100	6,1	50	135						
	NFC 2890	3,5	58	75	4,4	58	110	5,3	58	145				113	68,0	3/4"
		4,0	74	50	5	74	78	5,8	74	115						
		4,6	94	33	5,8	94	60	6,4	94	85						
50°	NFN 2120	2,2	2	55	2,9	2	68	3,8	2	94	80	48,3	3/4"			
		2,8	6	40	3,6	6	52	4,4	6	75						
		3,3	9	30	4,2	9	42	5,3	9	62						
	NFN 2275	2,5	7	145	3,2	7	190	4,2	7	250				113	68,0	3/4"
		3,5	17	115	4,2	17	160	5,3	17	200						
		4,6	27	100	5,5	27	135	6,4	27	180						
	NFN 2340	2,6	15	150	3,2	15	185	4,2	15	230				113	68,0	3/4"
		3,3	34	100	4,2	34	125	5,2	34	170						
		4,3	50	70	5,2	50	100	6,1	50	135						
	NFN 2890	3,5	58	75	4,4	58	110	5,3	58	145				113	68,0	3/4"
		4,0	74	50	5	74	78	5,8	74	115						
		4,6	94	33	5,8	94	60	6,4	94	85						

VALUES FOR CODING PARAMETERS

- | | | | |
|---|---|--|--|
| <p>A Nozzle type</p> <ul style="list-style-type: none"> A NEB 1490 B NEB 1740 C NEB 2140 D NEB 2190 E NEB 2260
 G NFC 2120 H NFC 2275 K NFC 2340 L NFC 2890 M NFC 3150
 O NFN 2120 P NFN 2275 Q NFN 2340 R NFN 2890 S NFN 3150
 X Special | <p>B Nozzle material</p> <ul style="list-style-type: none"> A AISI 316 L B Hastelloy C 276 C Hastelloy C 22 D Hastelloy C 4 E Other
 C External pipe material See nozzle material codes
 D Internal pipe material See nozzle material codes
 E Flange material See nozzle material codes
 G Nozzle direction L Nozzle in line M Nozzle 45° up N Nozzle 90° up | <p>Y Nozzle 45° down</p> <p>Z Nozzle 90° down</p> <p>X Other</p>
<p>H Flange design</p> <p>Connection flange design according to:</p> <ul style="list-style-type: none"> A ASA 10" 150# B 2550 NB flange BS4504 PN16 C Rectangular PNR standard D DIN DN 250 PN 16 X Other
<p>J Lance design</p> <ul style="list-style-type: none"> A Adjustable simple lances A Nominal length 500 mm B Nominal length 1000 mm C Nominal length 1500 mm D Adjustable non standard length lance | <p>F Lances with additional air cooling</p>
<p>H Lances with additional water cooling</p>
<p>K Lances with protection pipe</p>
<p>N Lances with air cooling and protection pipe</p>
<p>X Other lances</p> |
|---|---|--|--|

TYPICAL SYSTEM

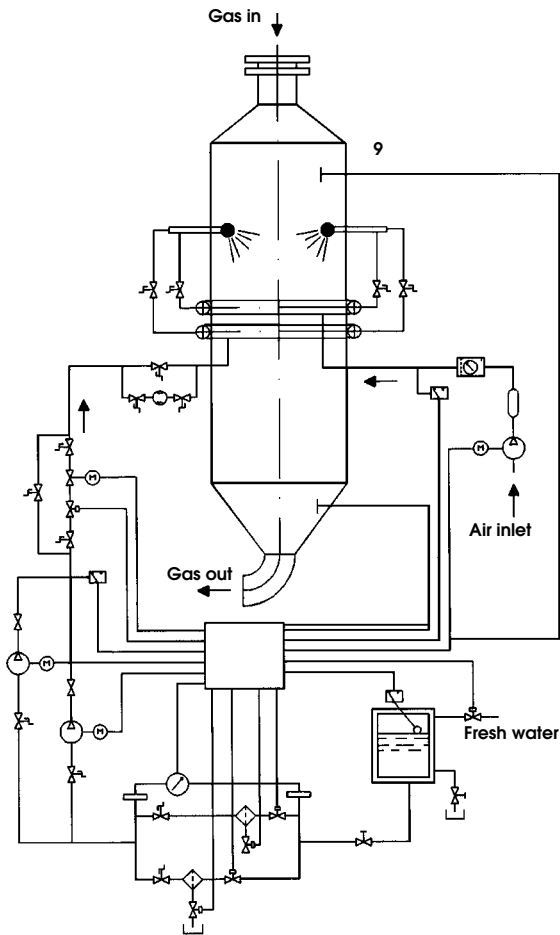

The diagrams on the left shows the typical lay-out for a gas cooling system based on air assisted atomizing lances (Please refer to page 2 for general considerations about cooling tower design).

The system is based on air assisted lances to provide for evaporative cooling action, where the values for outlet gas temperature are continuously monitored and kept within the specified range by a PLC, which provides for water and air pressure to be continuously regulated so as to supply enough cooling water.

The inlet gas temperature value is also picked-up at the tower entrance so that the regulation process can be better accomplished.

List of system parts

01	Main water pumps
02	Compressed air supply
03	Water filtration system
04	Water pressure regulation valve
05	Water flowmeter
06	Water pressure value pick-up
07	Air assisted lances
08	PLC/temperature control
09	Inlet gas temperature value pick-up
10	Out gas temperature value pick-up

REGULATION OF COOLING SYSTEMS

The complete system is driven by a PLC, which controls the working conditions and improves the global system efficiency while assuring a higher safety level.

By processing the signals received from different appropriate sensors the PLC performs the following functions:

- control and regulation of the cooling liquid flow rate
- control of inlet and outlet gas temperatures
- monitoring and recording all physical process parameters
- handling of emergency conditions

The PLC can also be programmed and equipped with dedicated sensors to perform additional tasks like keeping liquid pH control, or monitoring filter efficiency keeping differential pressure under control.

The PLC drives the regulation valve according to the variation of the outlet gas temperature, based on the difference between the set-point and the actual value.

The PID regulation must be adjusted according to the individual system characteristics.

ABBREVIATIONS

A	Air inlet diameter/thread	mm	LP	Liquid pressure	bar
AC	Air capacity	Ncm/h	N	Number of orifices	-
D	Orifice diameter	mm	RFA	Air thread connection	Inches
De	Outside diameter	mm	RFL	Liquid thread connection	Inches
L	Lenght	mm	W	Liquid inlet diameter	mm
LC	Liquid capacity	Lpm			

PRODUCT WARRANTY

Pnr products will be replaced or repaired, at the option of Pnr and free of charges, if found defective in manufacturing, labeling or packaging.
 The above warranty conditions will apply if notice of defect is received by Pnr within 30 days from date of product installation or one year from date of shipment.
 The cost of above said replacement or repair shall be the exclusive remedy for any breach of any warranty, and Pnr shall not be held liable for any damage due to personal injuries or commercial losses coming from product malfunction.

Our Company Procedure for warranty requires the following steps:

- 1 Contact our Quality Manager and obtain from Pnr a return authorization number
- 2 Return the products together with our form 3DA A04 duly filled
- 3 We shall issue a test report, send you a copy and return the product (replaced or repaired).

Our Company scope is obtaining full Customer satisfaction, and we are fully aware of the inconvenience which can be originated from a defective product.
 Please be assured we shall do our best to make available a perfect product in the shortest possible time.

We also provide, for products which are not defective, a product return policy as follows.

PRODUCTS DELIVERED IN ERROR FROM PNR

- 1 Obtain from Pnr a return authorization number
- 2 Return the products together with our form duly filled
- 3 Pnr shall issue a Credit Note for full product and shipping costs.

PRODUCTS ORDERED INCORRECTLY TO PNR

- 1 Obtain from Pnr a return authorization number
- 2 Return the products, at your expense, together with our form duly filled
- 3 Products shall be in original conditions, inside the original packing
- 4 A re-stocking charge of 15% applies.
- 5 Pnr shall issue a credit note for 85% of the original product cost

NON CATALOG PRODUCTS

Can only be returned after a quotation from Pnr is obtained.

SENDING LIST

In order to receive automatically updates of our Catalogues, please photocopy the card below and mail it to any Pnr Office in a sealed envelope. Your details will be recorded into our permanent mailing list.

CTG LN16 BR

01	COMPANY		SPRAY NOZZLES
02	NAME		AIR ASSISTED ATOMIZERS
03	FUNCTION		EVAPORATIVE COOLING LANCES
04	ADRESS		SPRAYDRY NOZZLES
05	PHONE	FAX	TANK WASHING SYSTEMS
06	WEB SITE	E MAIL	ACCESSORIES AND FITTINGS



磐亞噴霧系統(常州)有限公司

江蘇省常州市太湖東路9-4號 常州創意產業園D棟921室 郵編213022

Tel : 0519-89661671 Fax : 0519-89661673

Website : www.pnr-china.com

E-mail : sales@pnr-china.com

CTG LN16 BR



Our products are distributed through:

PNR America
PNR Asia
PNR Benelux

PNR Brasil
PNR Czech Republic
PNR Deutschland
PNR France

PNR Italia
PNR Mexico
PNR U. Kingdom

We are moreover represented in:

Argentina
Australia
Austria
Canada
Chile
Denmark
Finland
Greece
India

Indonesia
Iran
Ireland
Japan
Slovenia
Korea
Nepal
Norway
N. Zealand

Pakistan
Poland
Portugal
Singapore
South Africa
Spain
Sweden
Taiwan
Venezuela